

od km 0+000,00 - do km 0+132,68

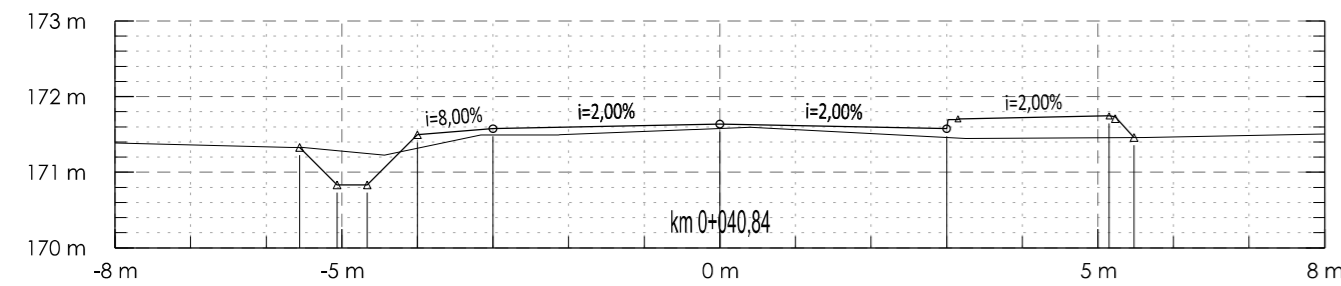

Odl. od osi:	-5,56	-5,06	-4,66	-4,00	-3,00	0,00	3,00	5,15	5,48
Proj. rzędne:	171,33	170,83	170,83	171,50	171,58	171,64	171,58	171,75	171,46

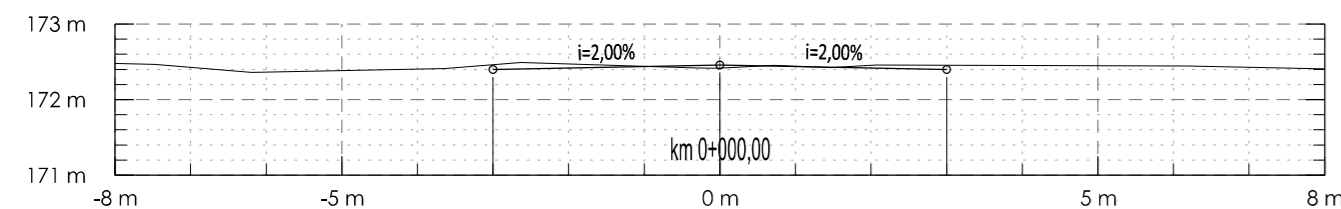

Odl. od osi:	-3,00	0,00	3,00
Proj. rzędne:	172,40	172,46	172,40

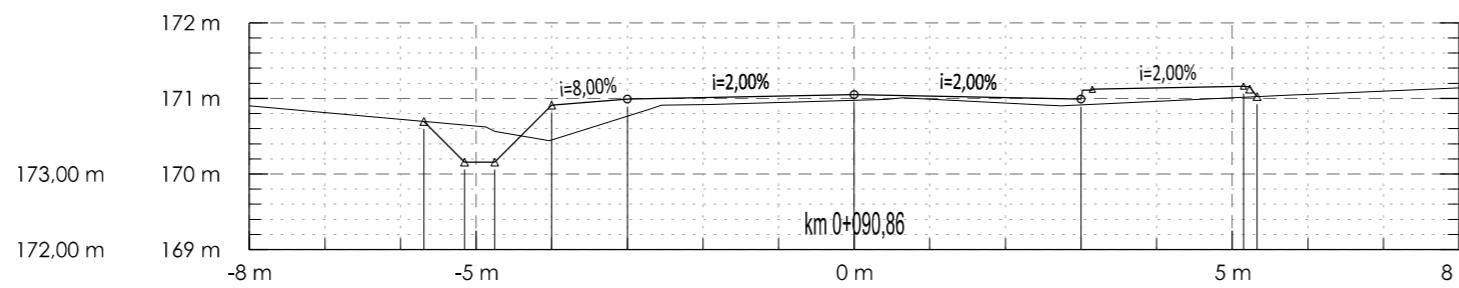

Odl. od osi:	-5,69	-5,15	-4,75	-4,00	-3,00	0,00	3,00	5,15	5,48
Proj. rzędne:	170,69	170,16	170,16	170,91	170,99	171,05	170,99	171,16	171,13

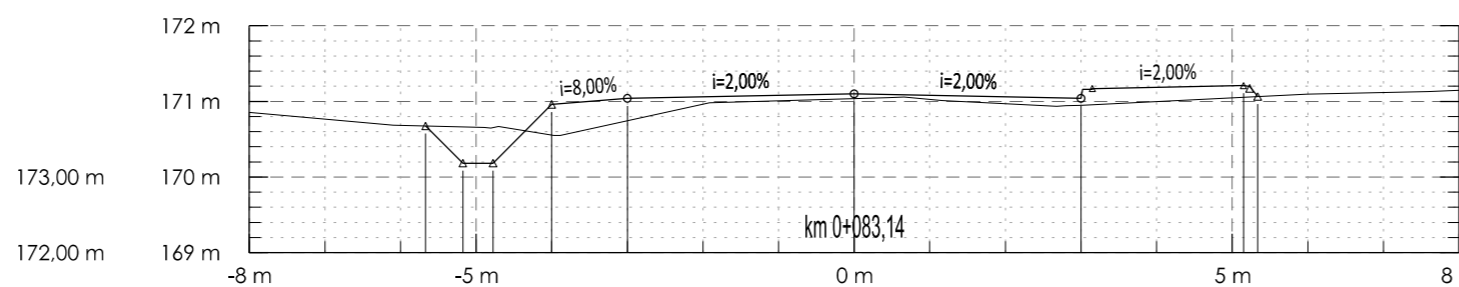

Odl. od osi:	-5,67	-5,18	-4,78	-4,00	-3,00	0,00	3,00	5,15	5,48
Proj. rzędne:	170,67	170,18	170,18	170,96	171,04	171,10	171,04	171,16	171,13

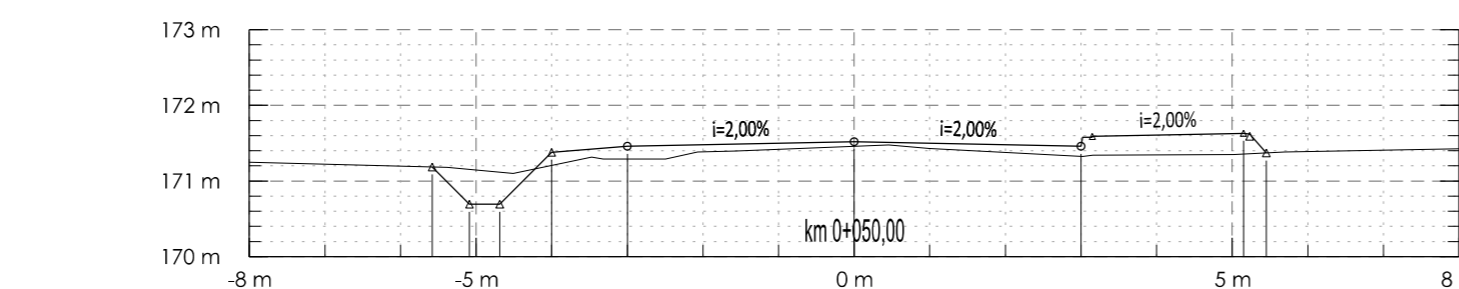

Odl. od osi:	-5,58	-5,09	-4,69	-4,00	-3,00	0,00	3,00	5,15	5,45
Proj. rzędne:	171,19	170,69	170,69	171,38	171,46	171,52	171,46	171,63	171,37

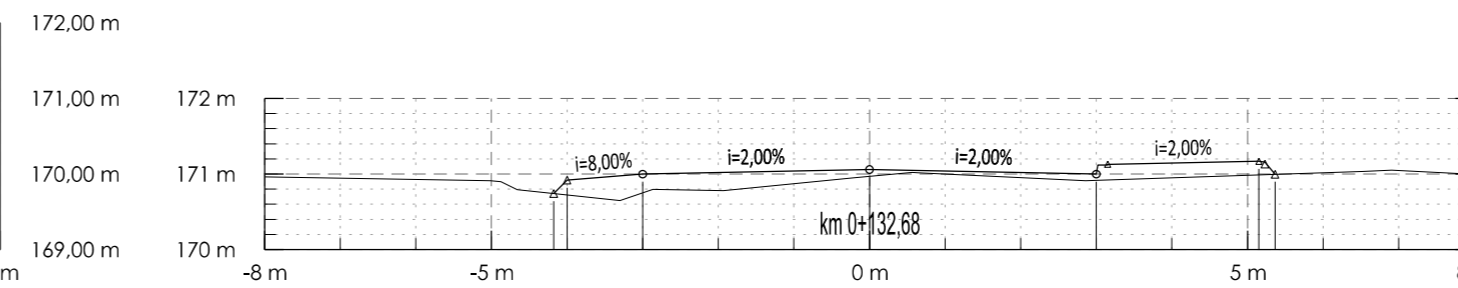

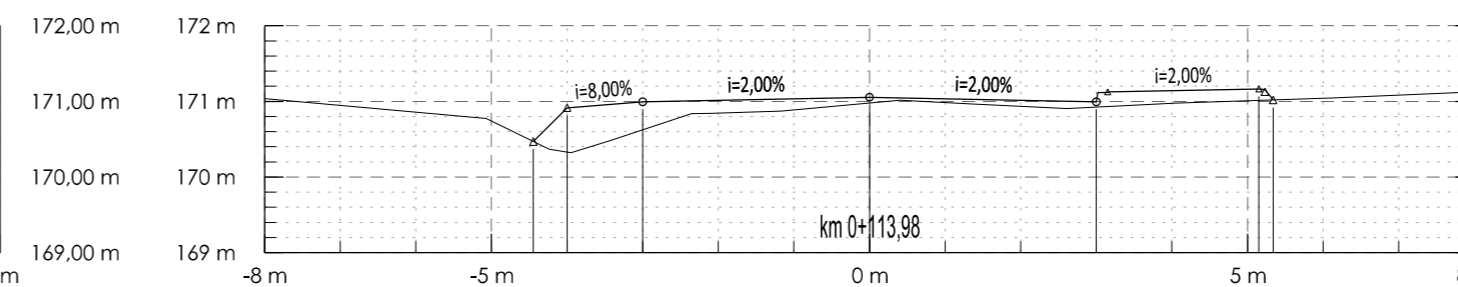

Odl. od osi:	-4,68	-3,00	0,00	3,00	5,15	5,48
Proj. rzędne:	170,54	171,00	171,06	171,00	171,17	171,13

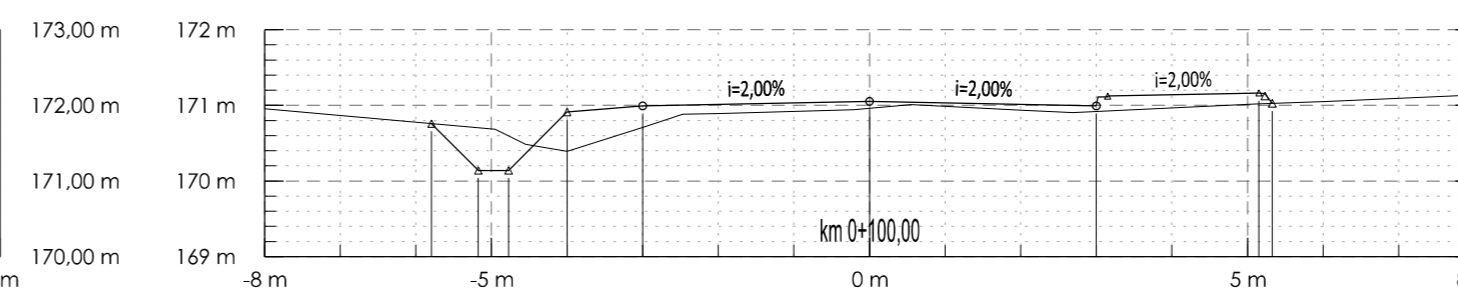

Odl. od osi:	-4,45	-4,00	-3,00	0,00	3,00	5,15	5,48
Proj. rzędne:	170,47	170,92	171,00	171,06	171,00	171,17	171,13



Odl. od osi:	-5,79	-5,17	-4,77	-4,00	-3,00	0,00	3,00	5,15	5,45
Proj. rzędne:	170,76	170,14	170,14	170,91	170,99	171,05	170,99	171,16	171,13

 Starostwo Powiatowe w Grójcu ul. Piłsudskiego 59 05-600 Grójec	Faza projektu: PROJEKT BUDOWLANO - WYKONAWCZY	
	Inżynieria ruchu: Projektant: mgr inż. Krzysztof Suliga upr. nr 83/DOS/12	
 Biuro Projektów Infrastrukturalnych Krzysztof Suliga, ul. Tęczowa 3/6, 05-270 Marki tel. 791 95 65 51, email: biuro@bpi-ks.pl	Sprawdzający: mgr inż. Bartłomiej Małek upr. nr MAZ/0405/POOD/10	
	Tom: TOM-I	Skala rysunku: 1:50
Inwestycja: PRZEBUDOWA DRÓG POWIATOWYCH NR 1602W WILCZORUDA - MICHRÓW I 1601W PNIEWY - REMBERTÓW		Tytuł rysunku: Przekroje charakterystyczna
		Nr rysunku: PC-1601-01

od km 0+000,00 - do km 0+269,68

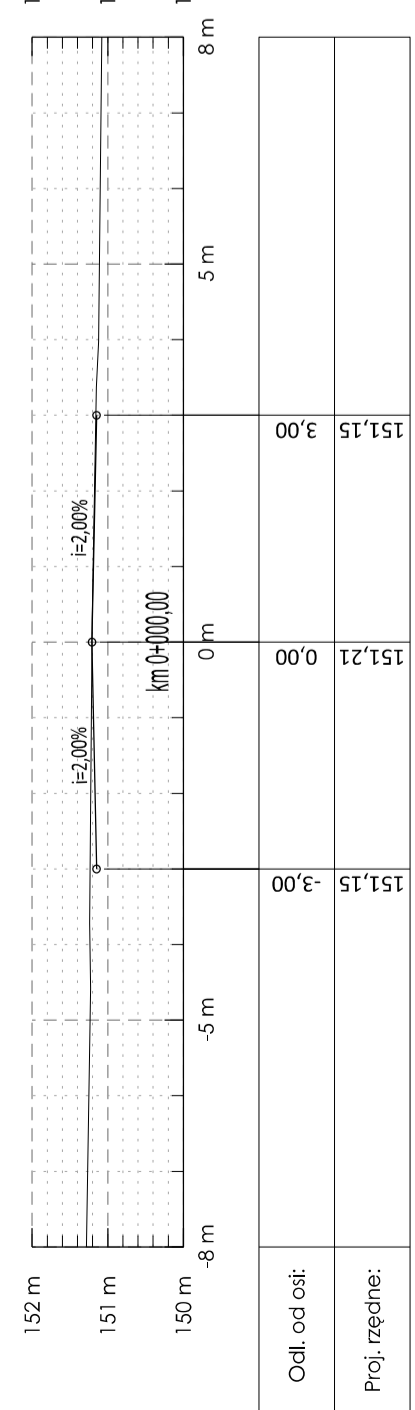
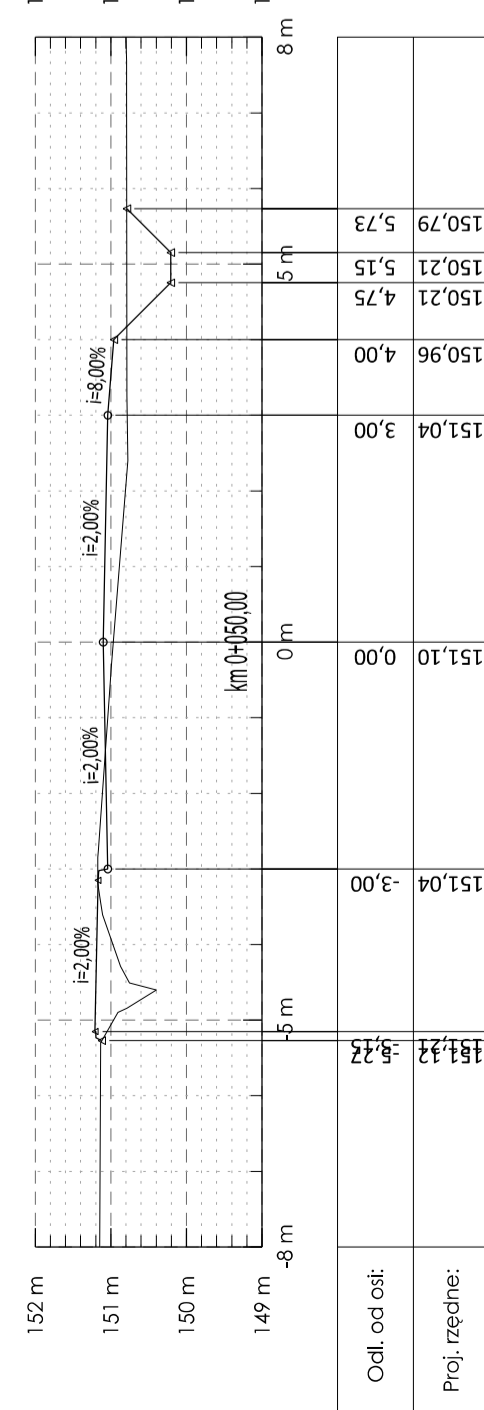
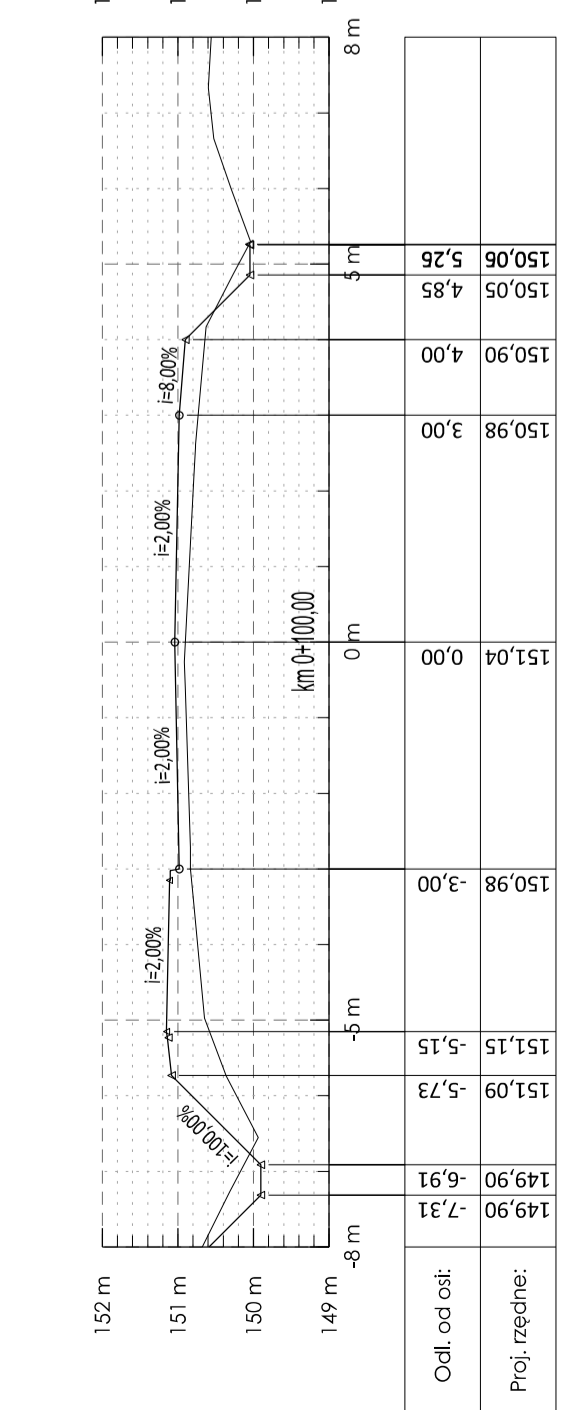
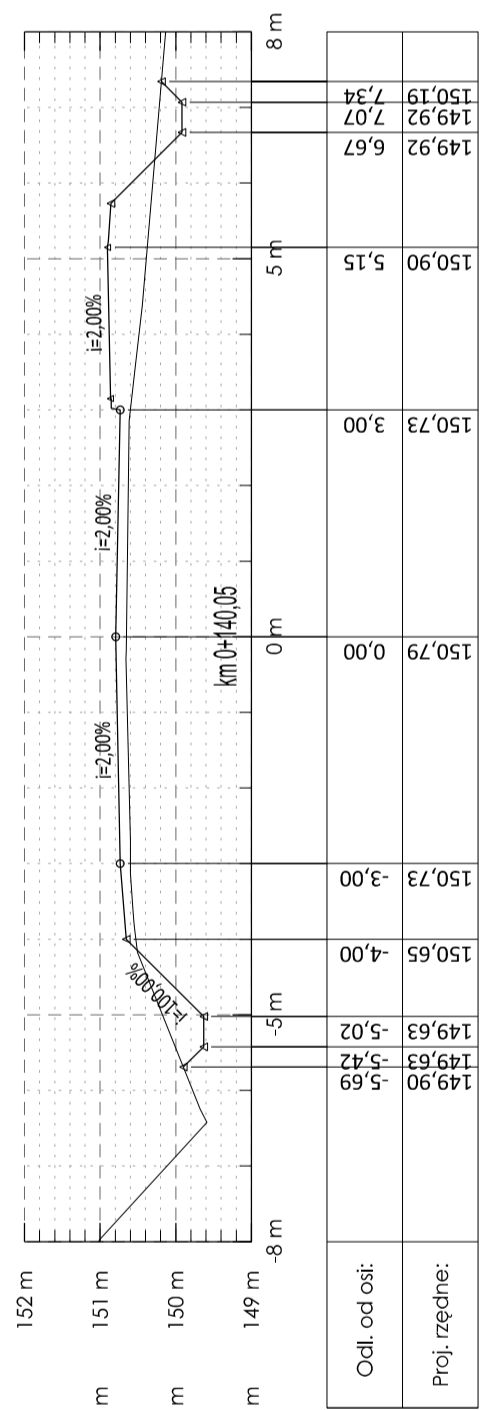
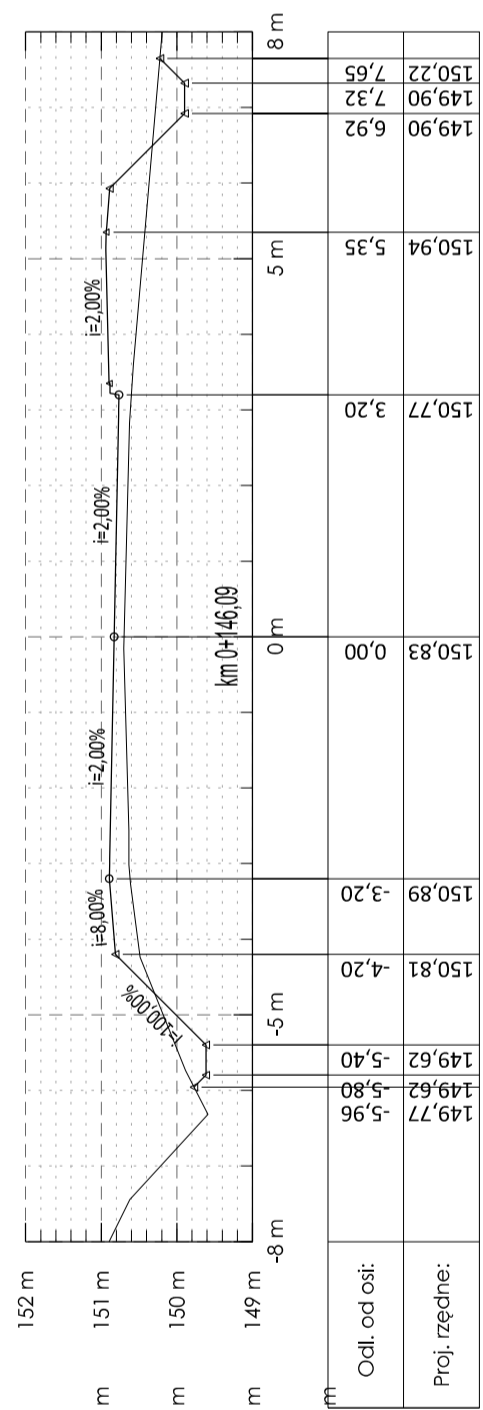
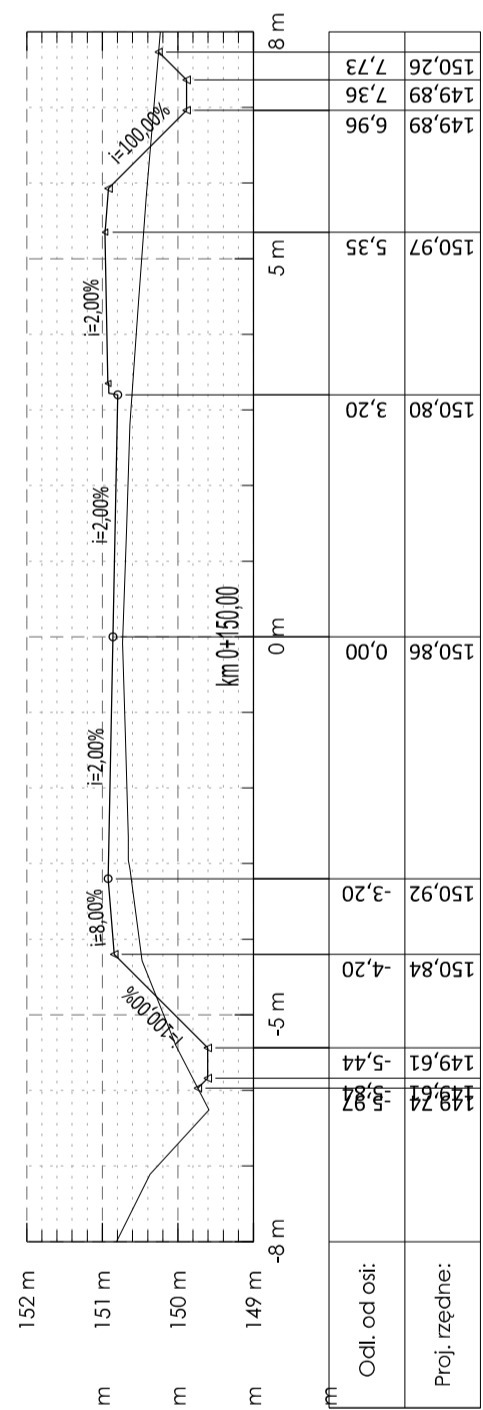
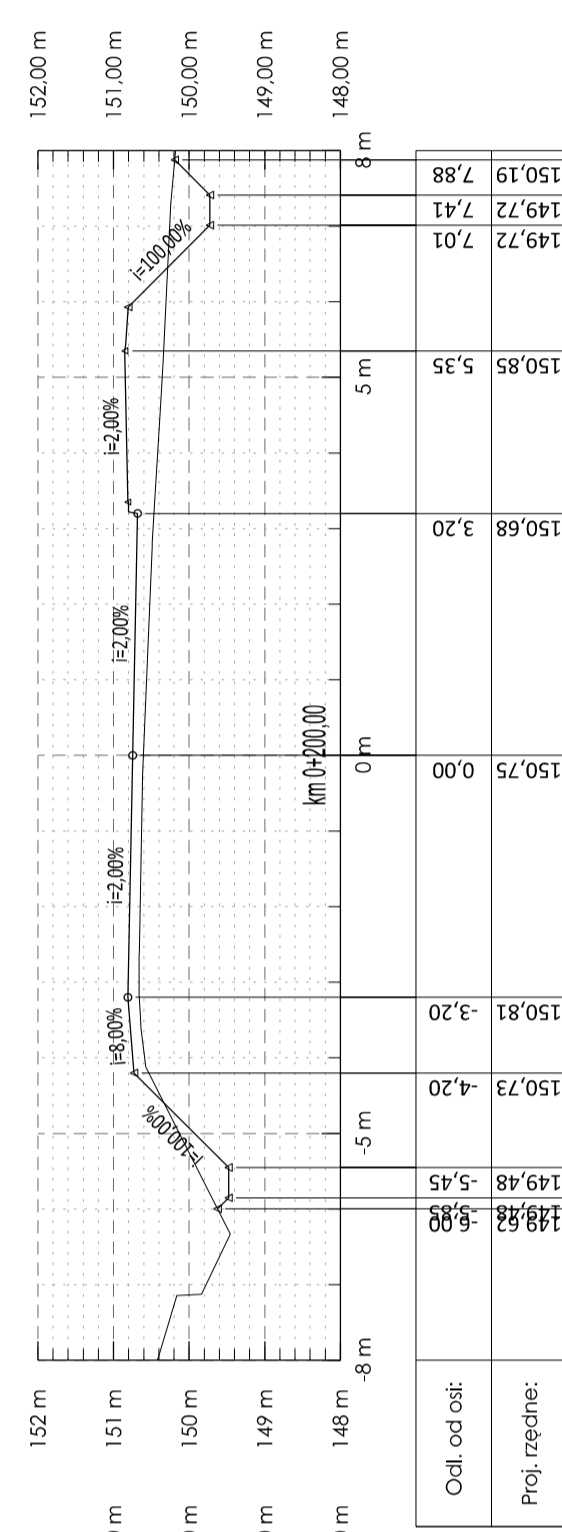
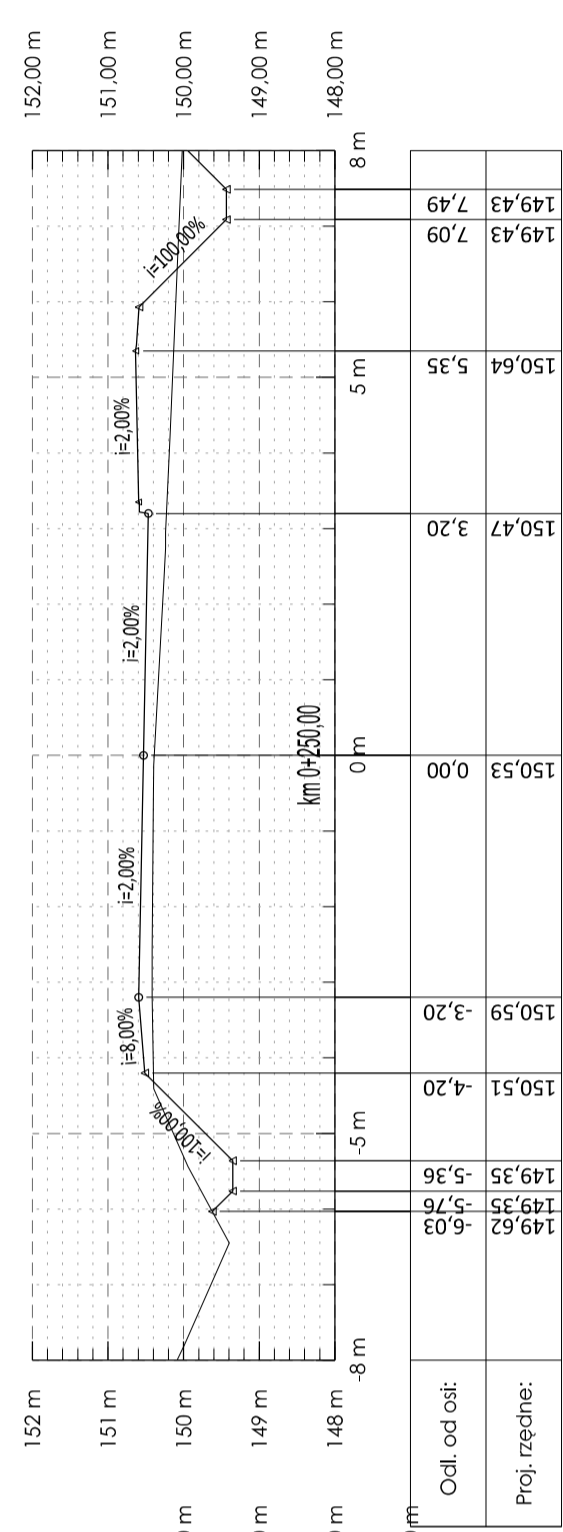
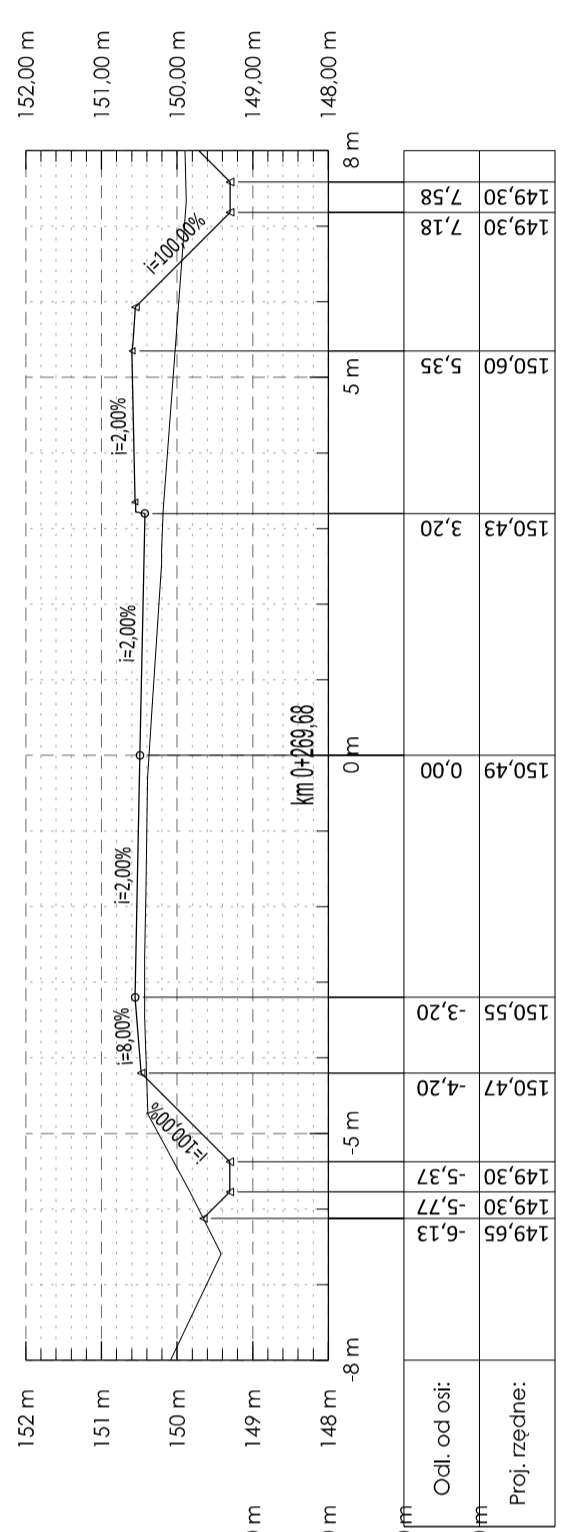

Wykonawca: **BPI**
Starostwo Powiatowe w Grojcu
 ul. Piłsudskiego 59
 05-600 Grojec

Projektant: mgr inż. Krzysztof Suliga
 upr. nr 63/PO/S/12

Sprawdzający: mgr inż. Bartłomiej Małętka
 upr. nr 1042/04/05/PO/07/10

Tom: TOM-I
Skala rysunku: 1:50

Data: VIII.2017

Faza projektu: PROJEKT BUDOWLANO - WYKONAWCZY

Tytuł rysunku: Przekroje charakterystyczne

Nr rysunku: PC-1602-01

od km 0+276,64 - do km 0+550,00

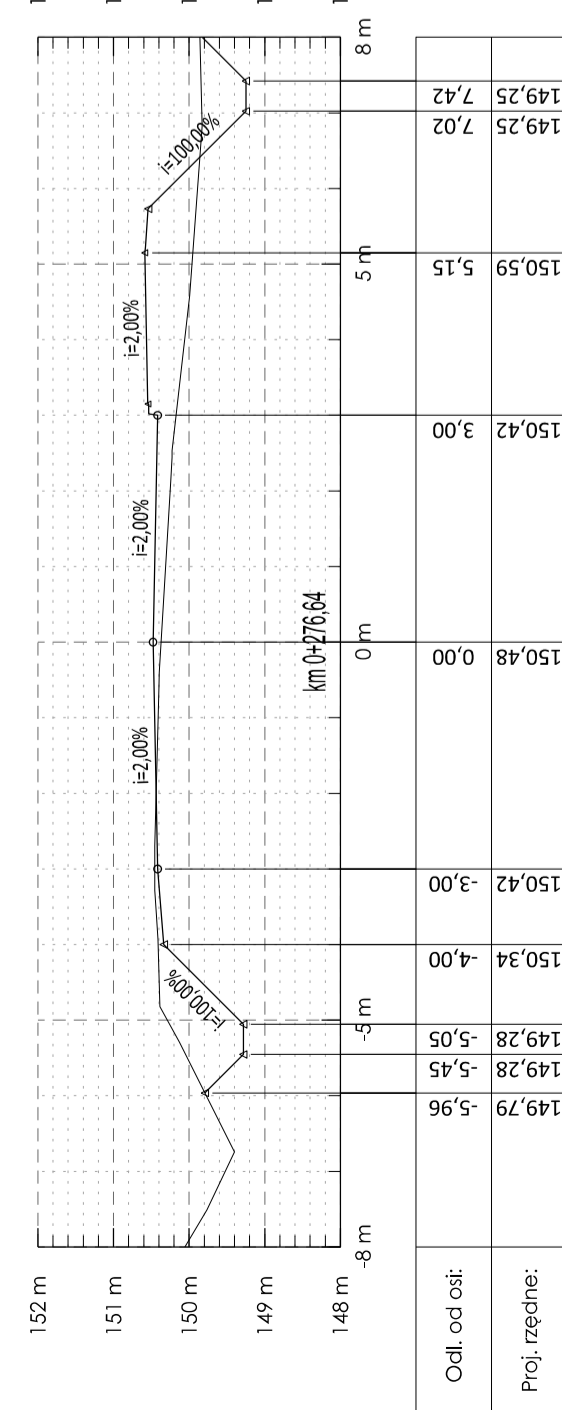
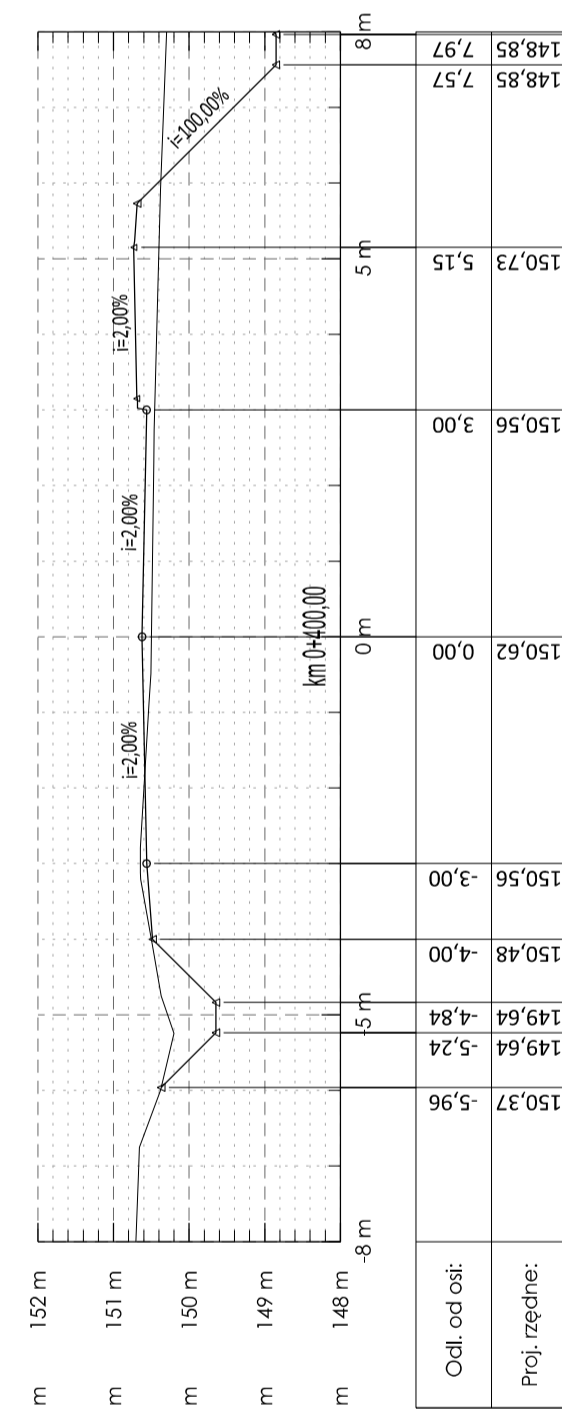
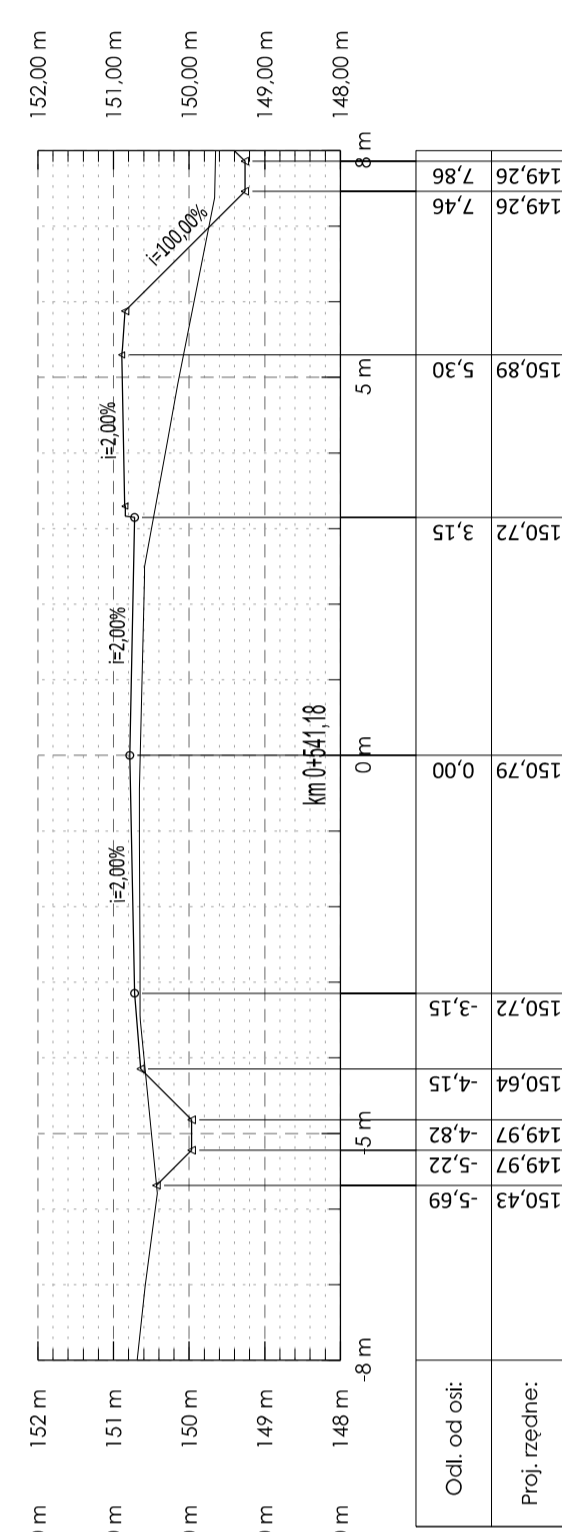
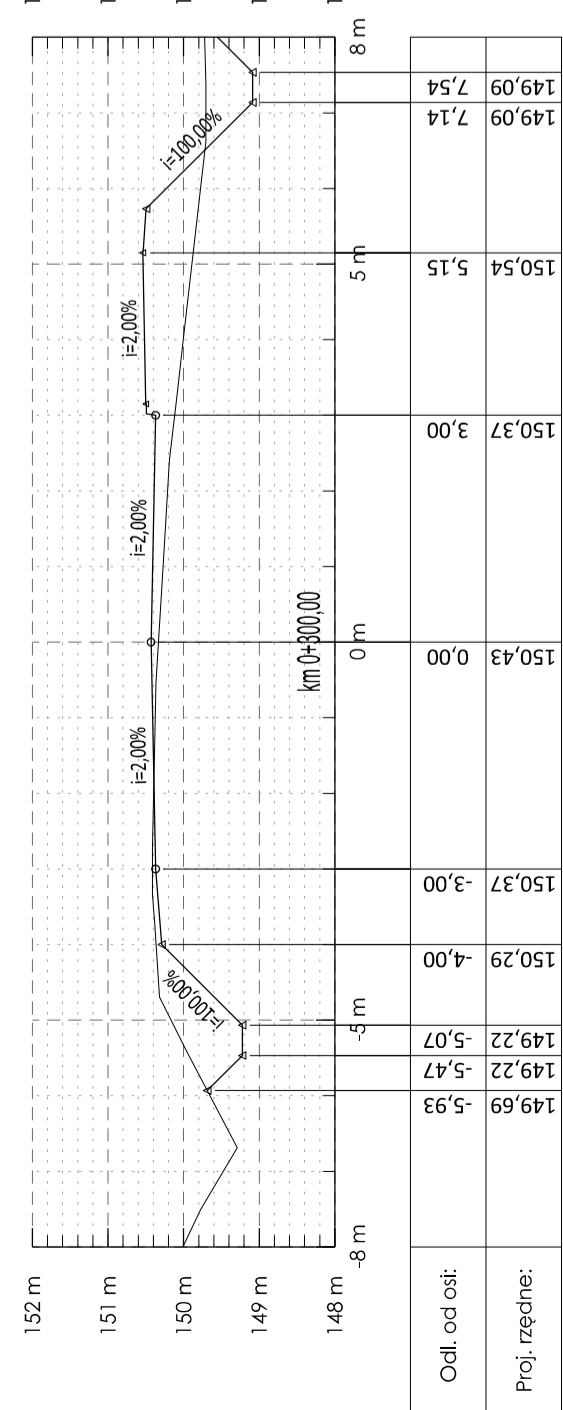
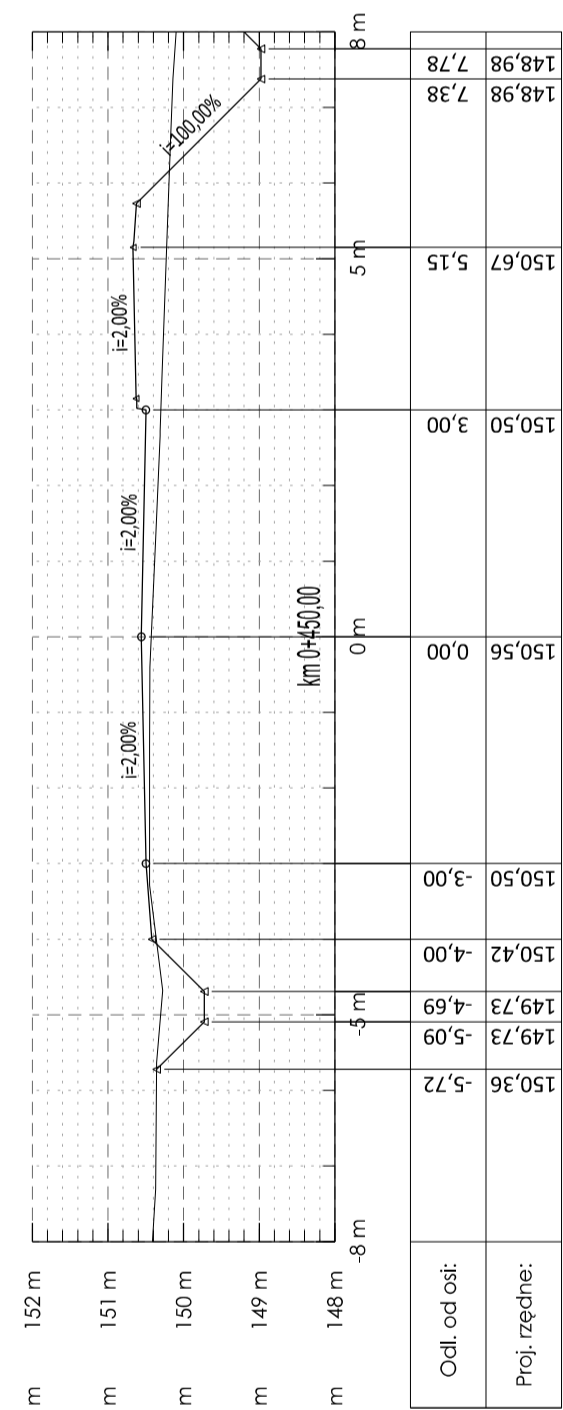
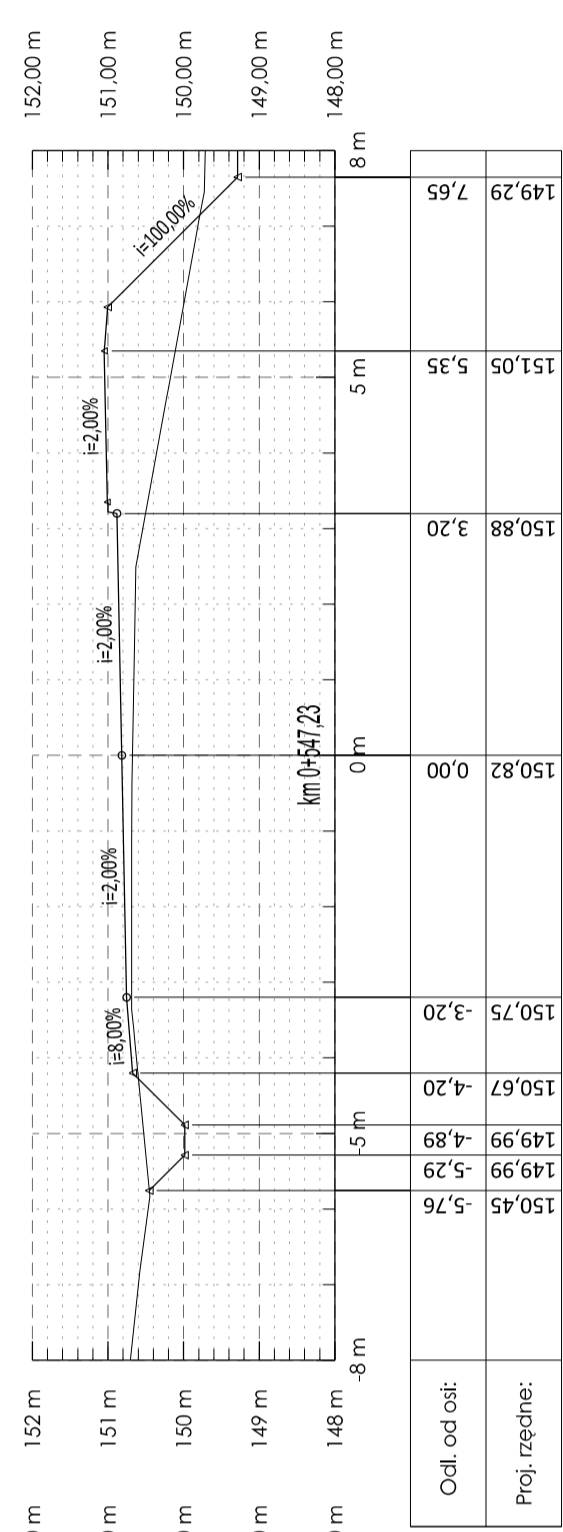
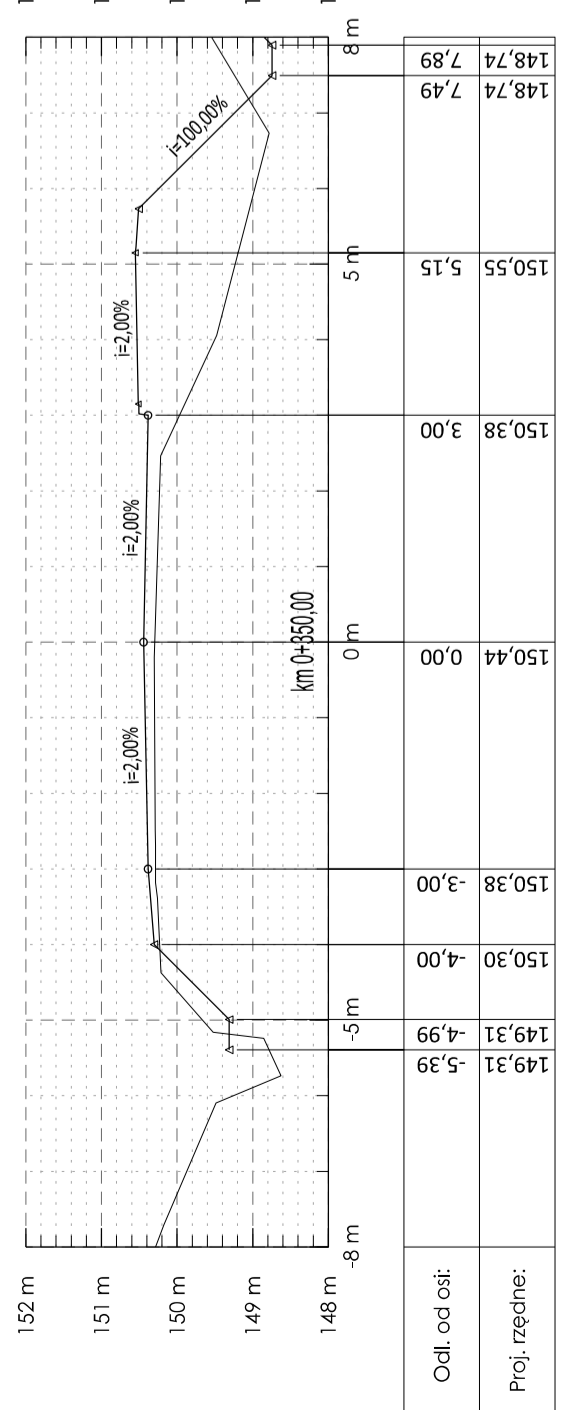
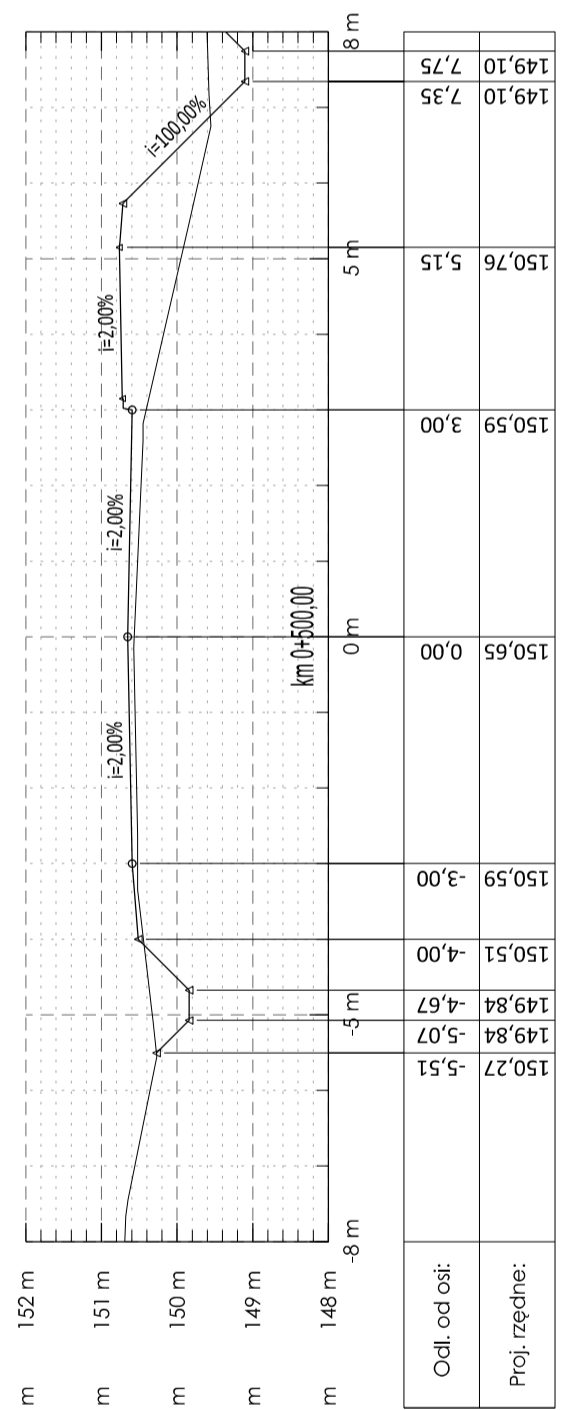
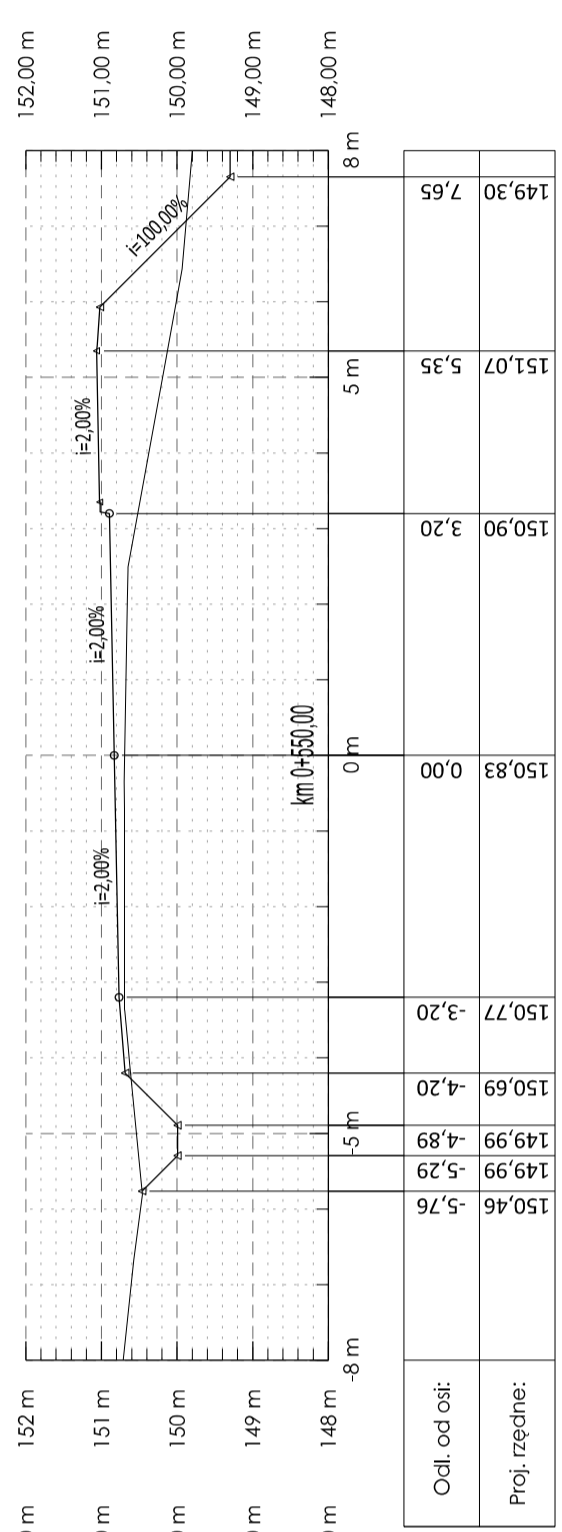

INWESTOR: Starostwo Powiatowe w Grojcu
ul. Piłsudskiego 59
05-600 Grojec

WYKONAWCA: BPI
Biurowy Projektów Infrastrukturalnych
Krzysztof Suliga, ul. Teczowa 3/6, 05-270 Marki
tel. 791 95 65 51, email: biuro@bpi-ke.pl

Faza projektu: PROJEKT BUDOWLANO - WYKONAWCZY

Projektant: mgr inż. Krzysztof Suliga
upr. nr 63/PO/S/12

Sprawdzający: mgr inż. Bartłomiej Małacka
upr. nr MAZ/0405/POD/10

Tom: TOM-I

Skala rysunku: 1:50

Data: VIII.2017

Tytuł rysunku: Przekroje charakterystyczne

Nr rysunku: PC-1602-02

od km 0+600,00 - do km 0+900,00

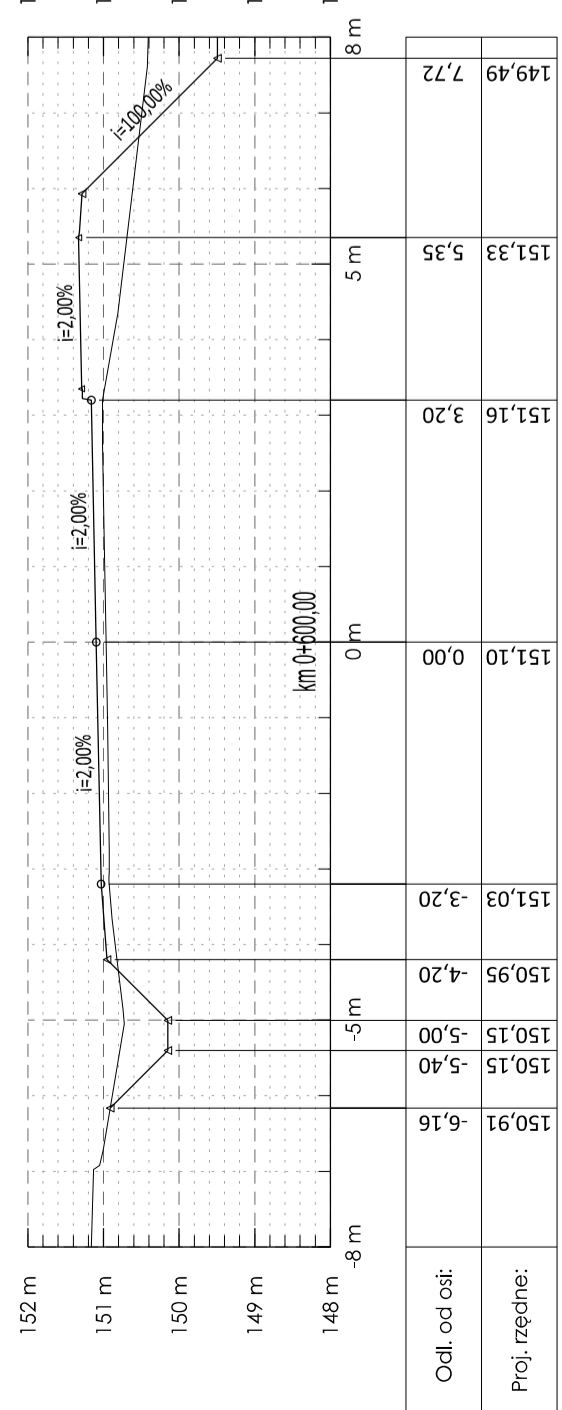
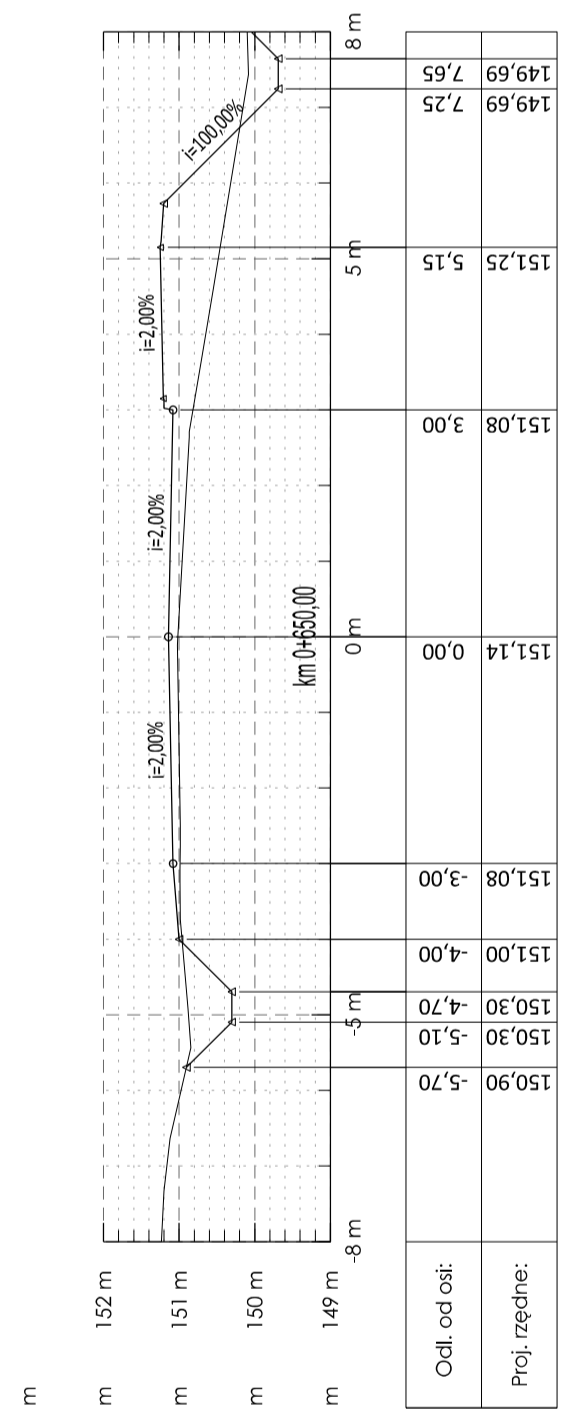
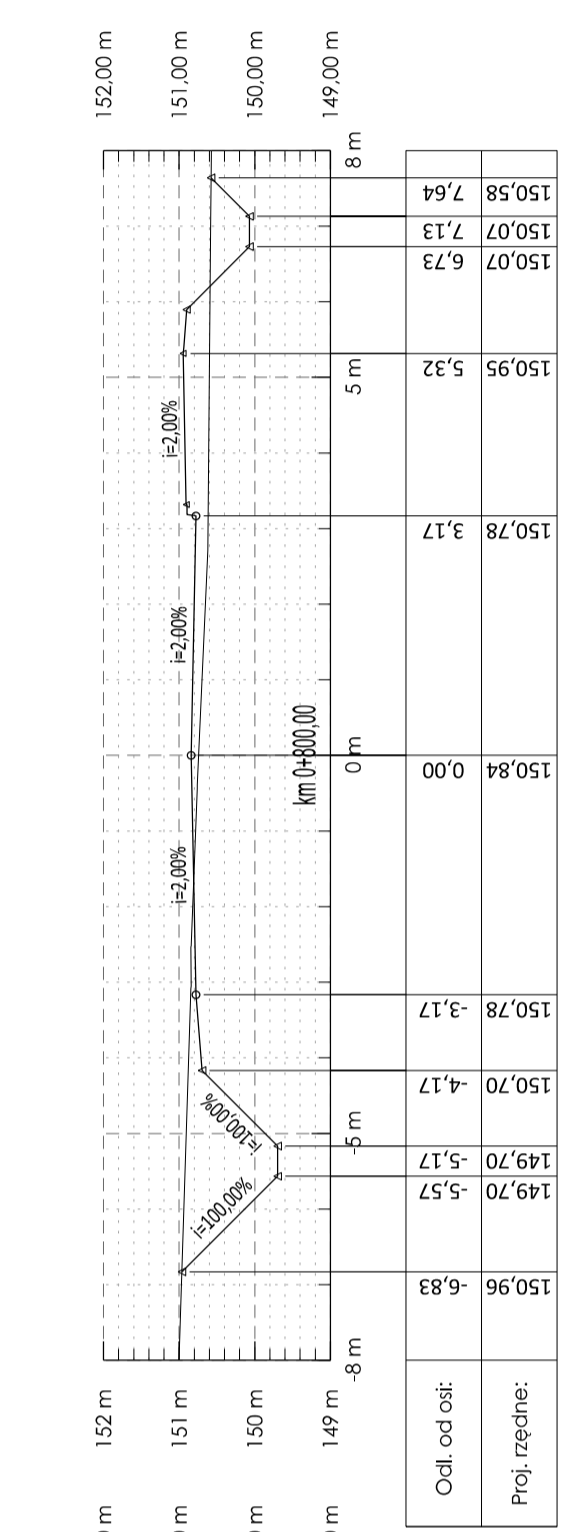
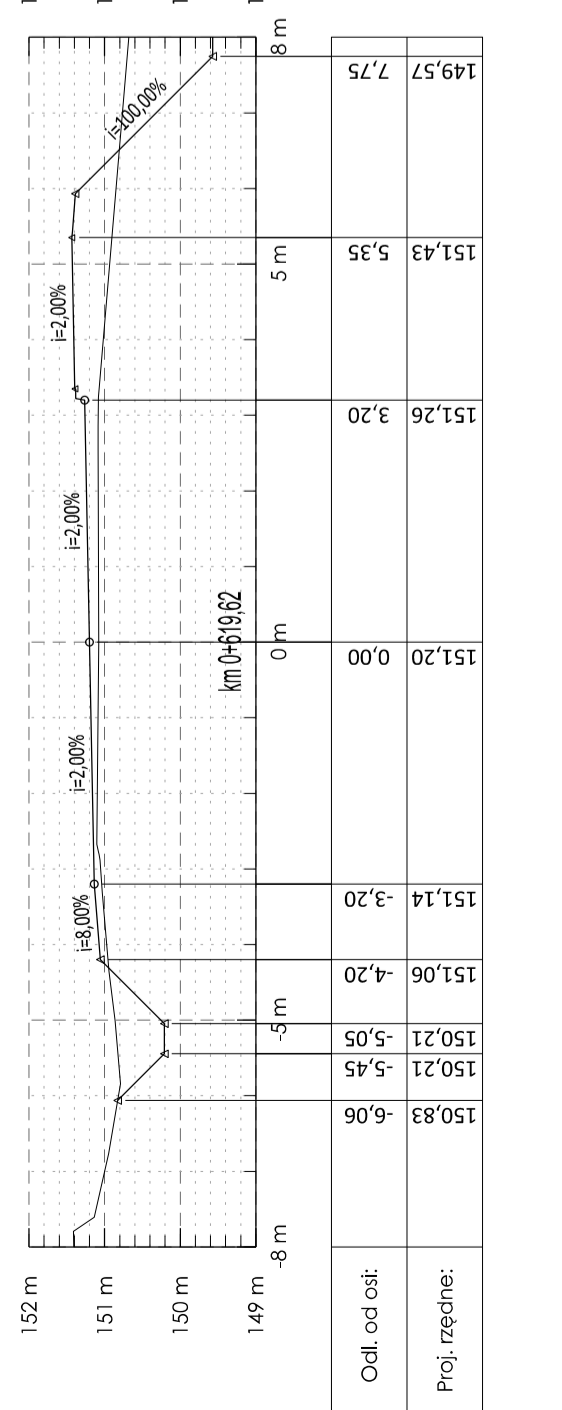
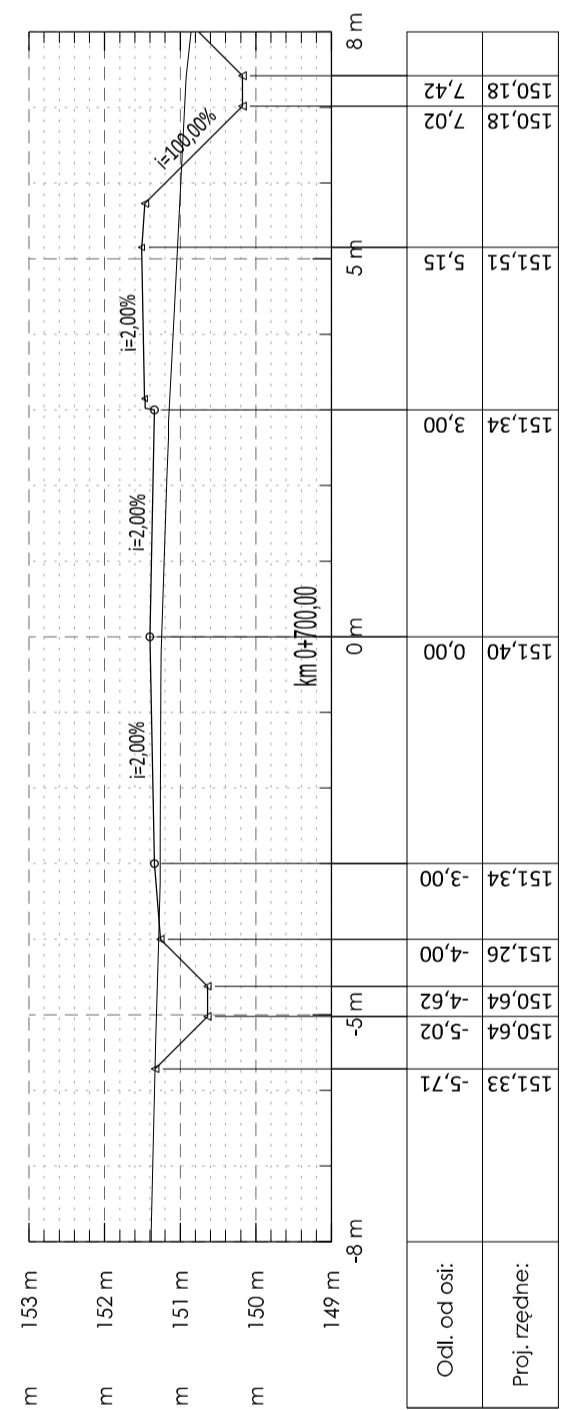
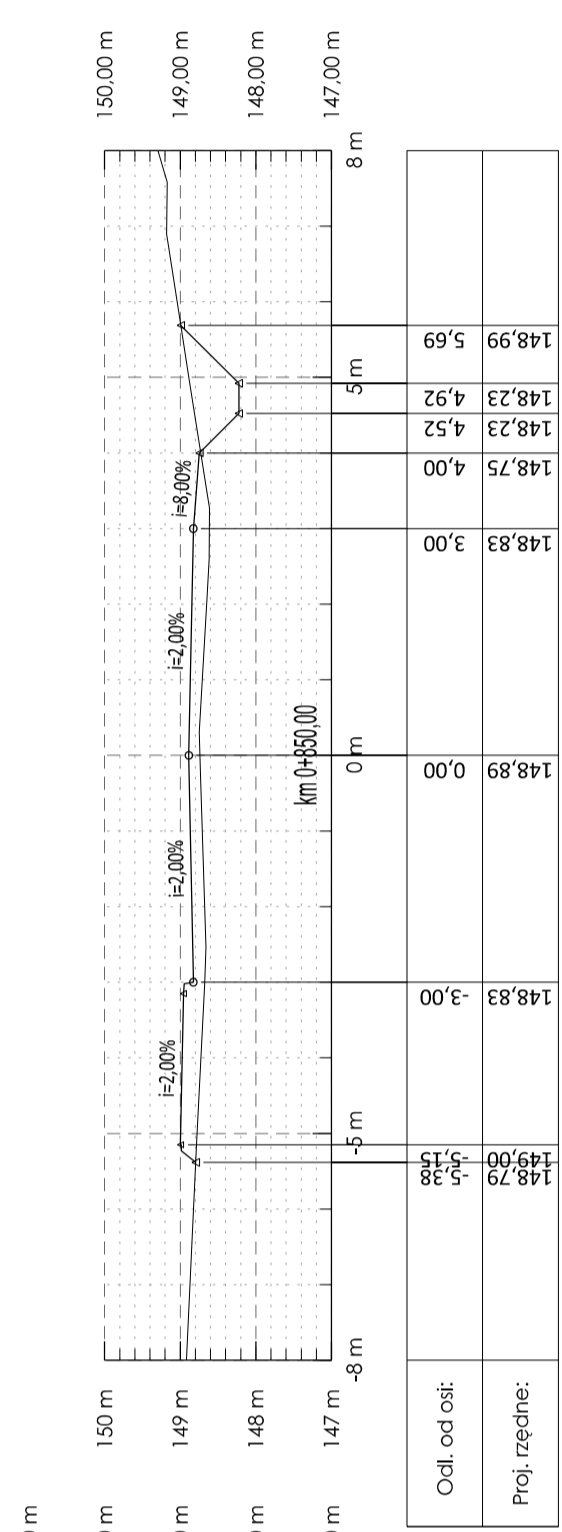
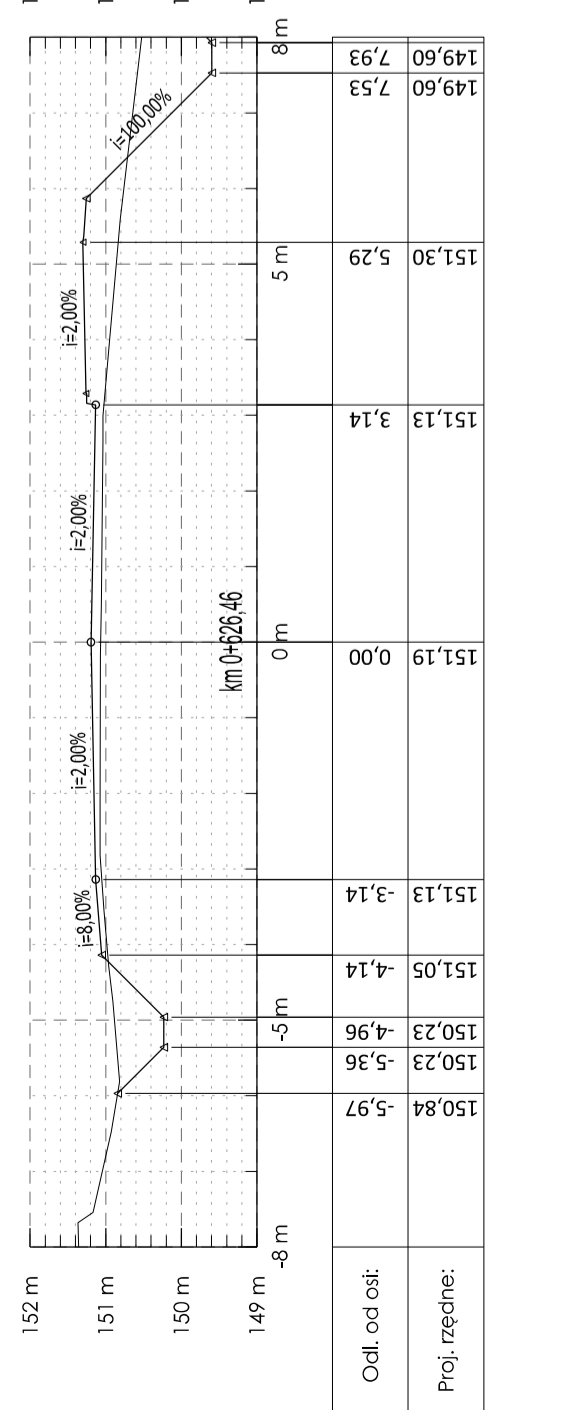
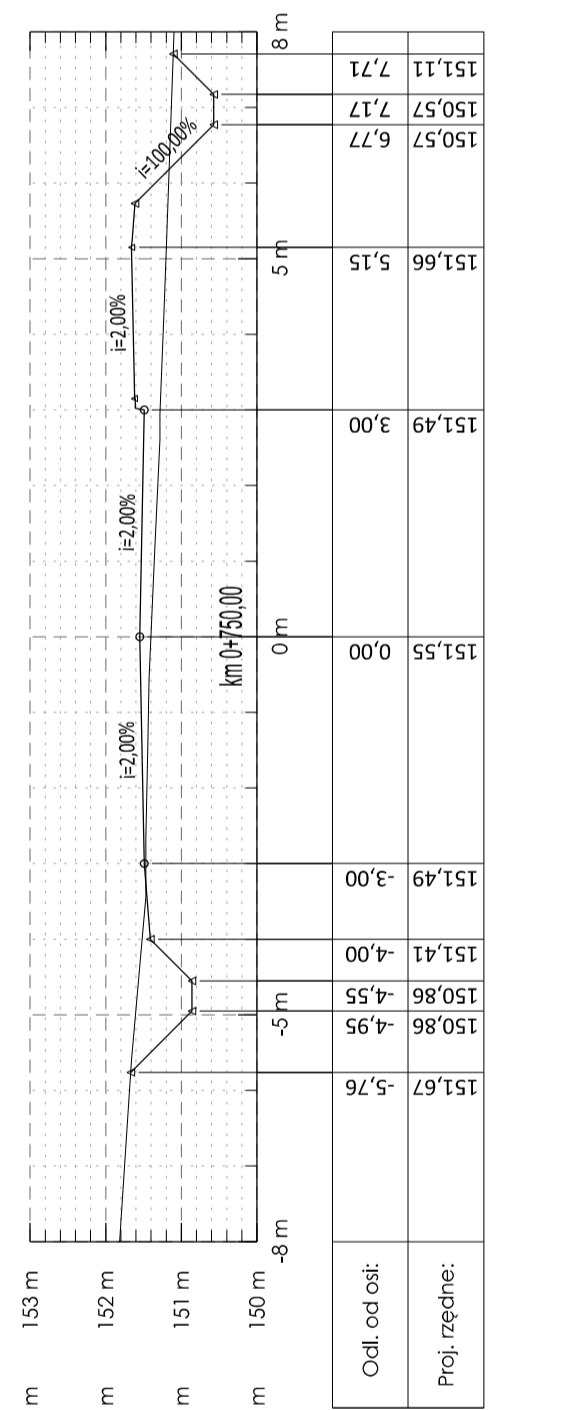
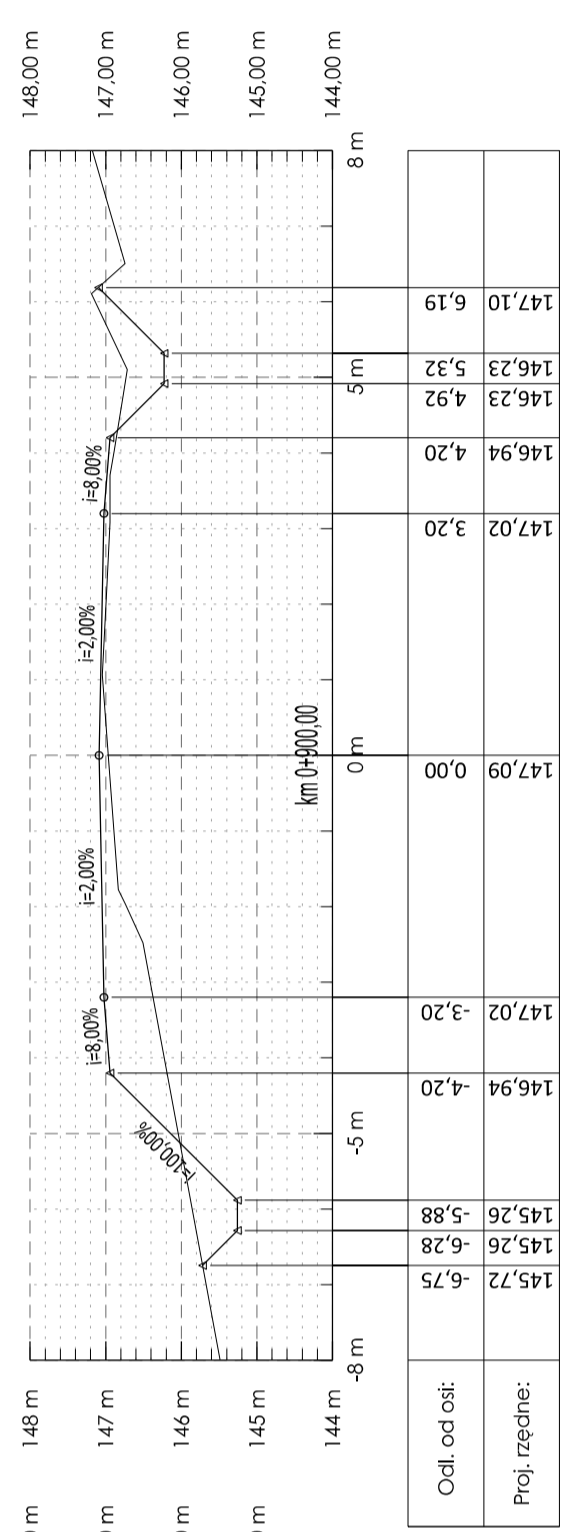

Starostwo Powiatowe w Grojcu
ul. Piłsudskiego 59
05-600 Grojec

BPI
Biurowo Projektów Infrastrukturalnych
Krysztof Suliga, ul. Teczowa 3/6, 05-270 Marki
tel. 791 95 65 51, email: biuro@bpi-ke.pl

PROJEKT BUDOWLANO - WYKONAWCZY

Projektant: mgr inż. Krzysztof Suliga
upr. nr 63/PO/S/12

Sprawdzający: mgr inż. Bartłomiej Małętka
upr. nr MIAZ/0405/POD/10

Tom: TOM-I
Skala rysunku: 1:50

Data: VIII.2017

Tytuł rysunku: Przekroje charakterystyczne

Nr rysunku: PC-1602-03

od km 0+950,00 - do km 1+237,28

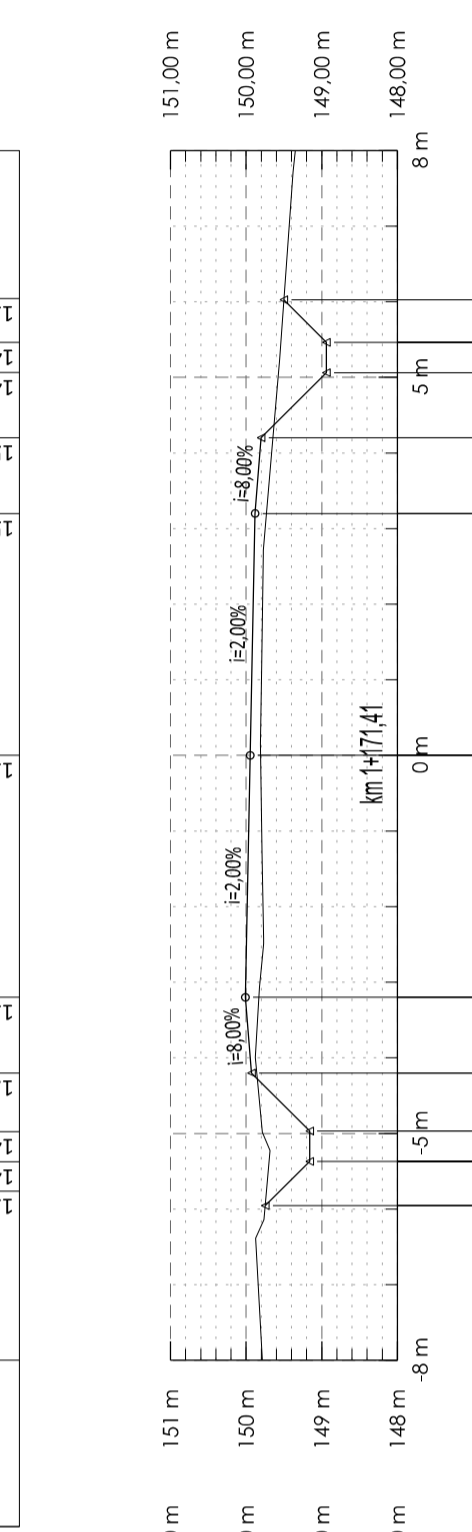
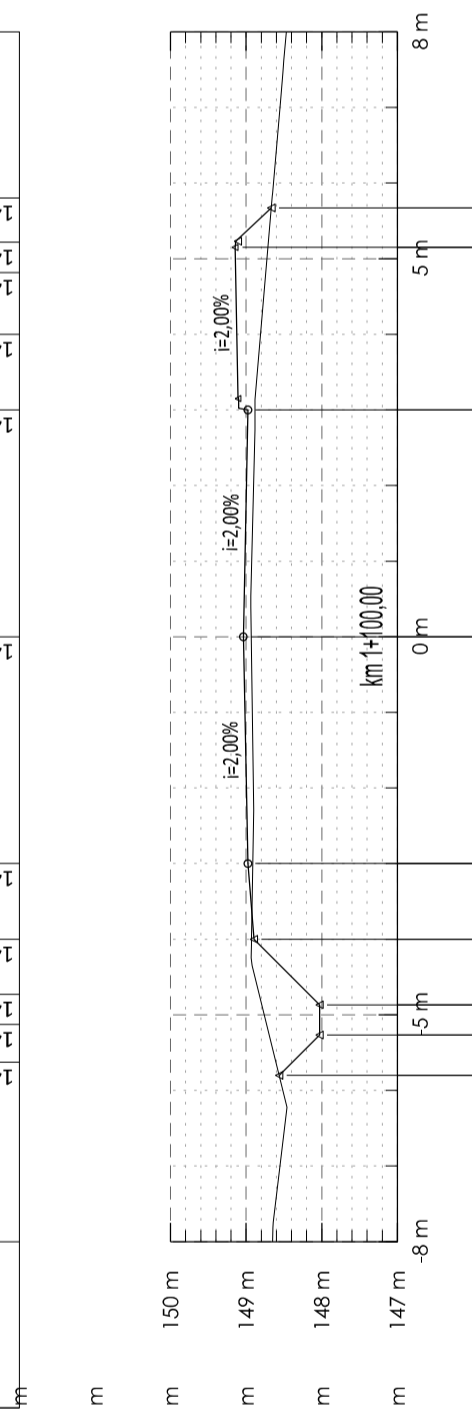
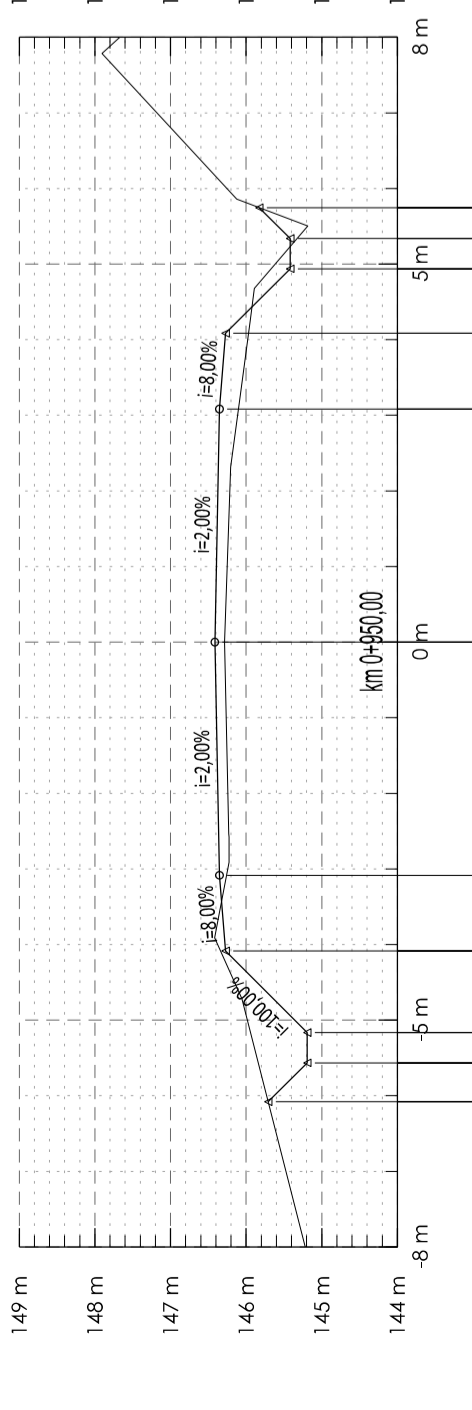
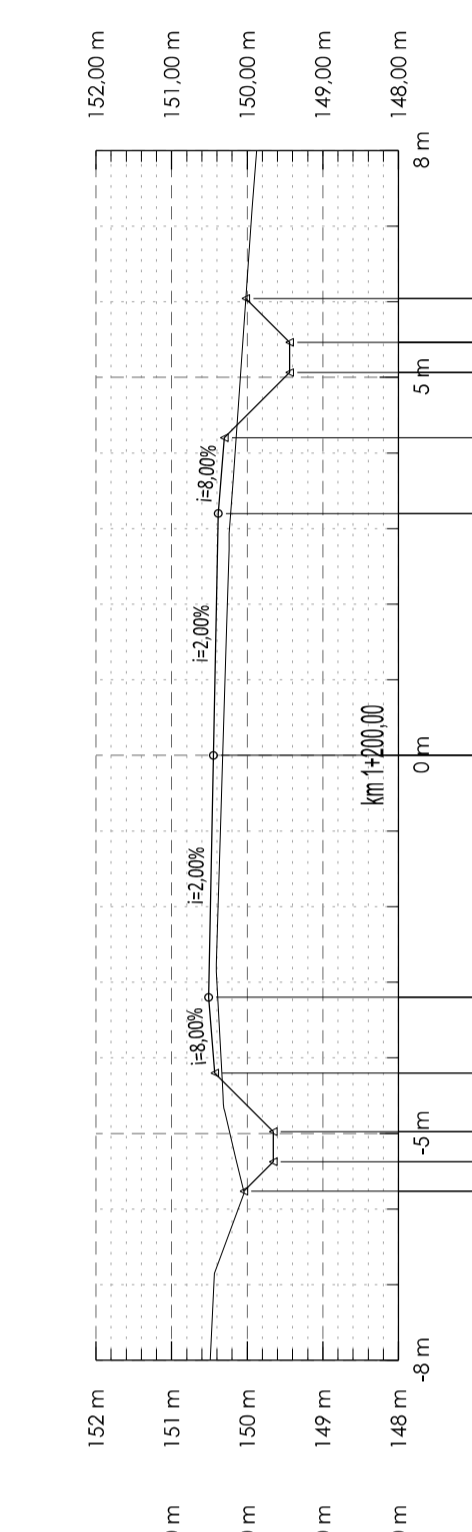
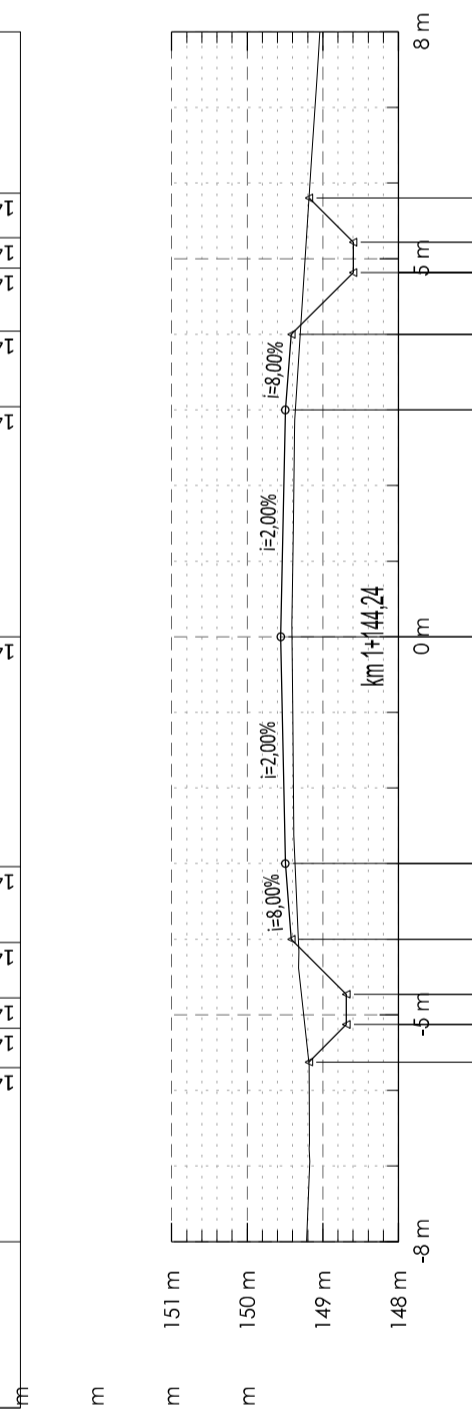
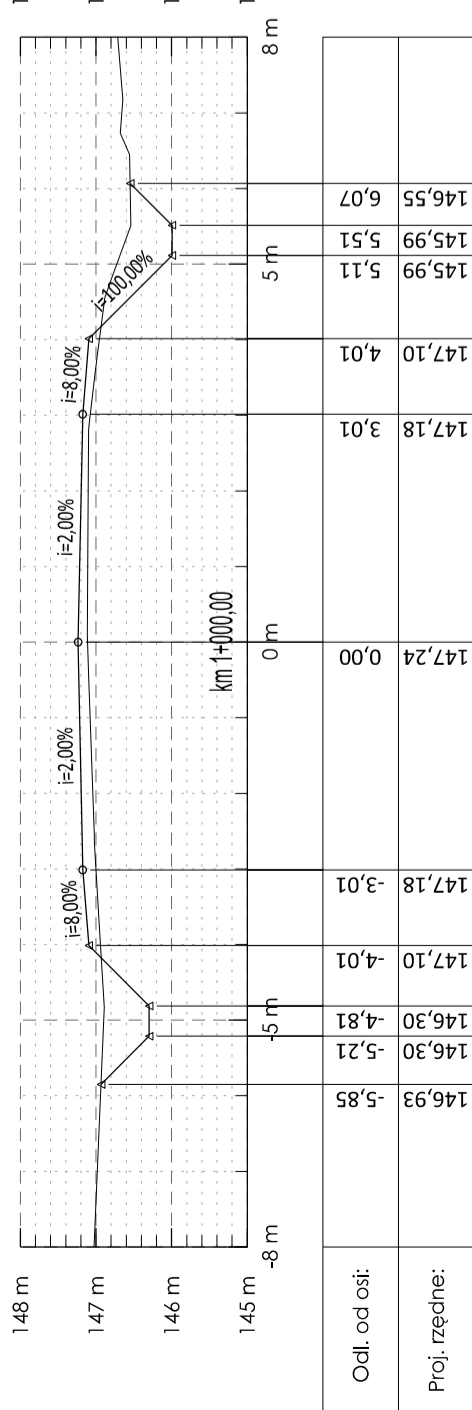
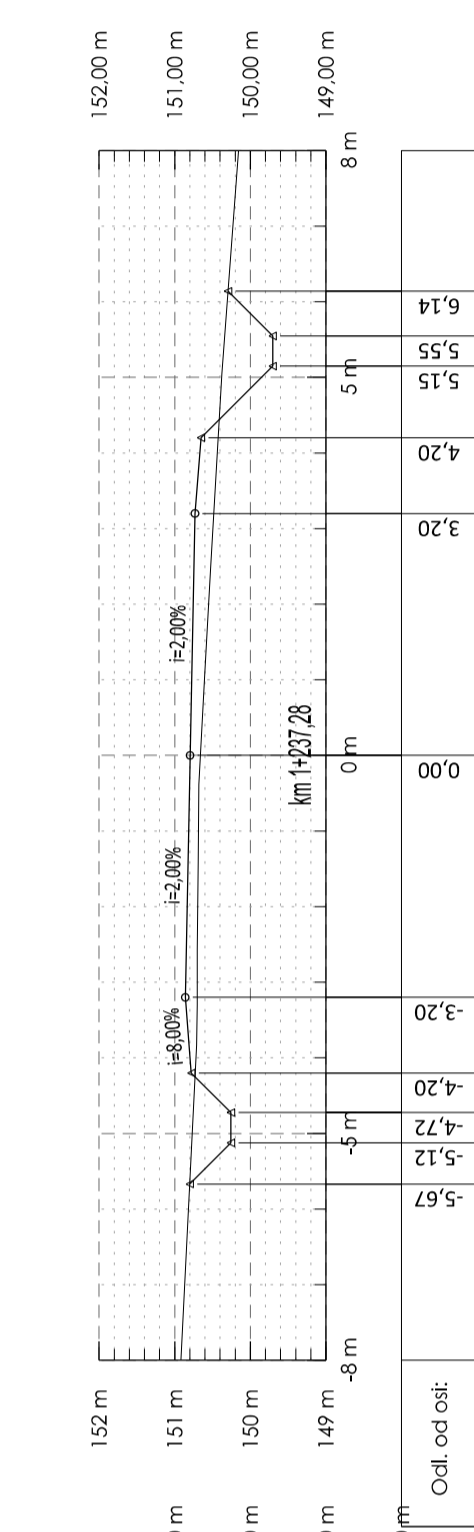
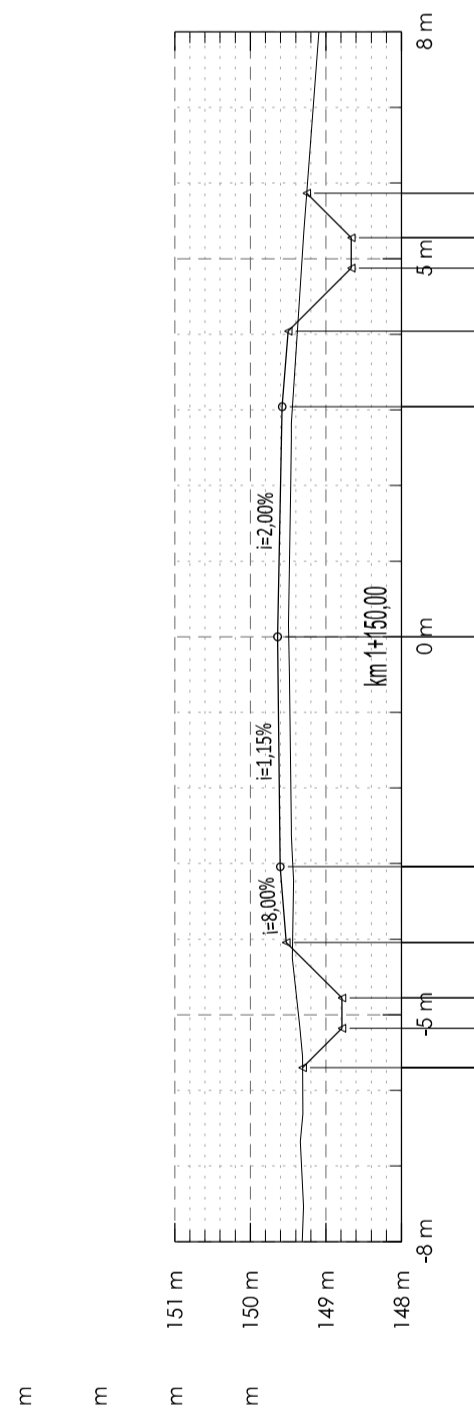
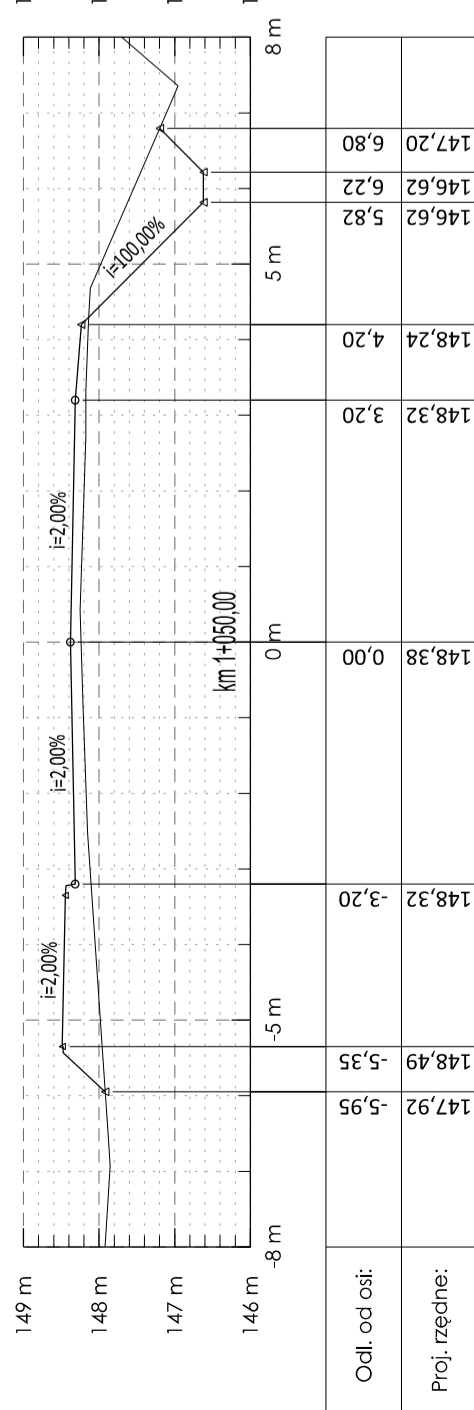

Wykonawca: Starostwo Powiatowe w Grojcu
ul. Piłsudskiego 59
05-600 Grojec

Wykonawca: BPI
Biurowo Projektów Infrastrukturalnych
Krzysztof Suliga, ul. Teczowa 3/6, 05-270 Marki
tel. 791 95 65 51, email: biuro@bpi-ke.pl

Faza projektu: PROJEKT BUDOWLANO - WYKONAWCZY

Projektant: mgr inż. Krzysztof Suliga
upr. nr 83/PO/S/12

Sprawdzający: mgr inż. Bartłomiej Małętka
upr. nr M/2/04/05/POD/10

Tom: TOM-I

Skala rysunku: 1:50

Data: VIII.2017

Tytuł rysunku: Przekroje charakterystyczne

Nr rysunku: PC-1602-04

od km 1+250,00 - do km 1+600,00

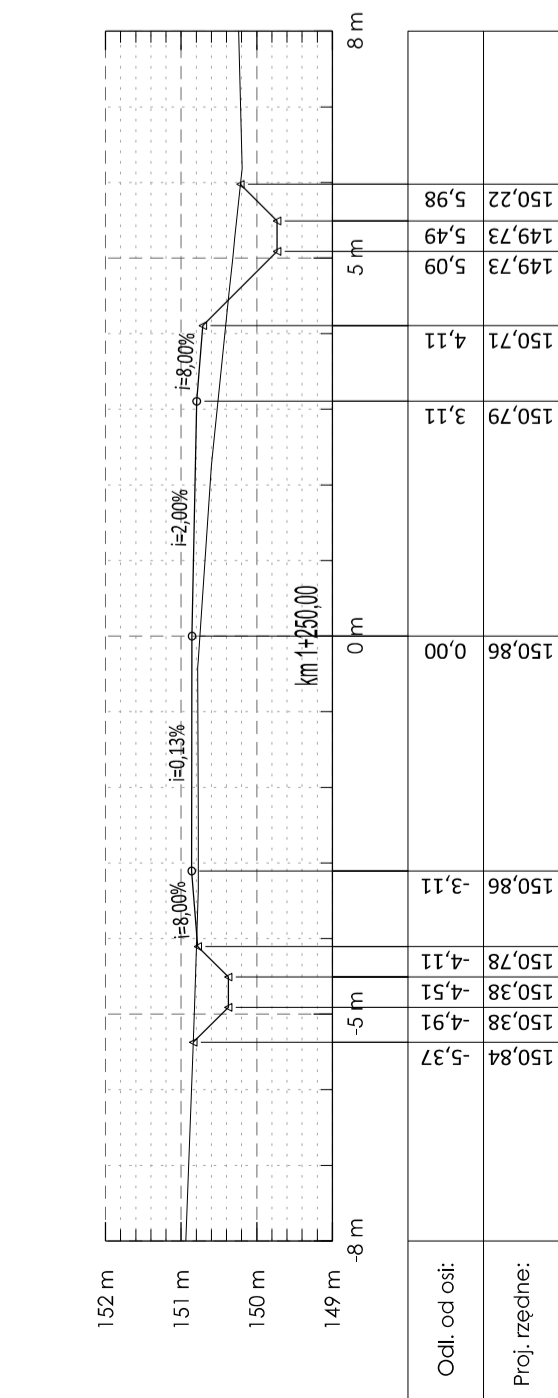
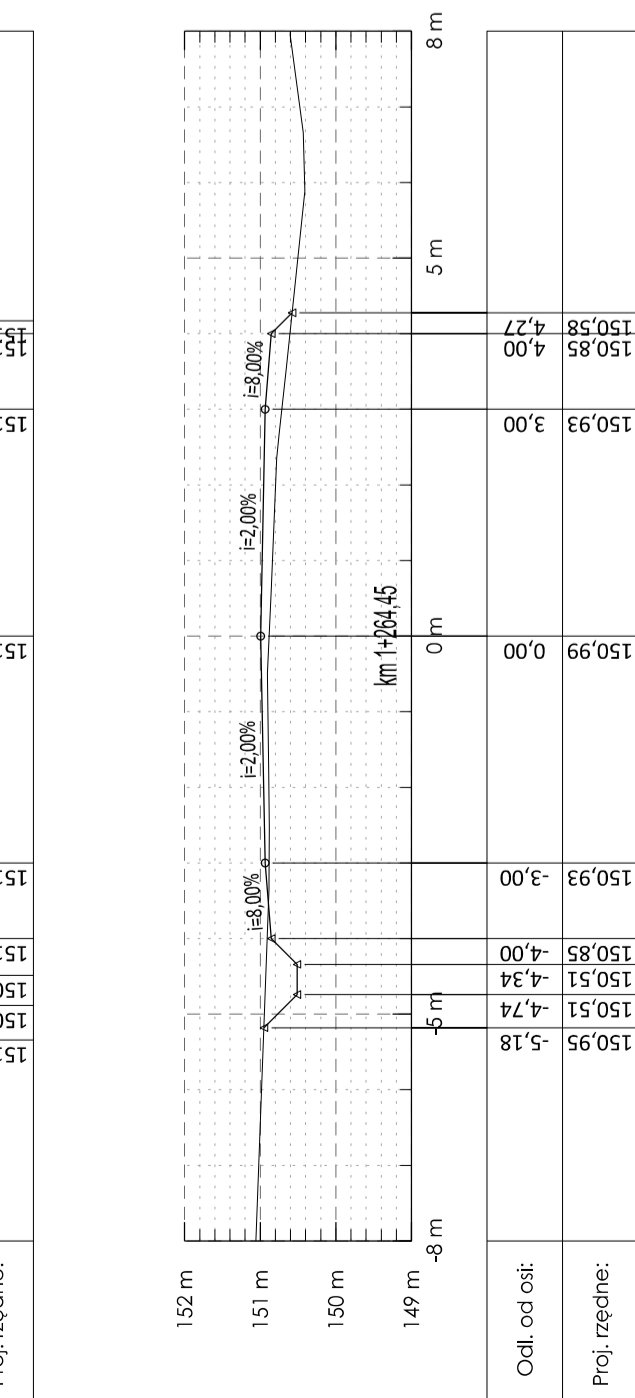
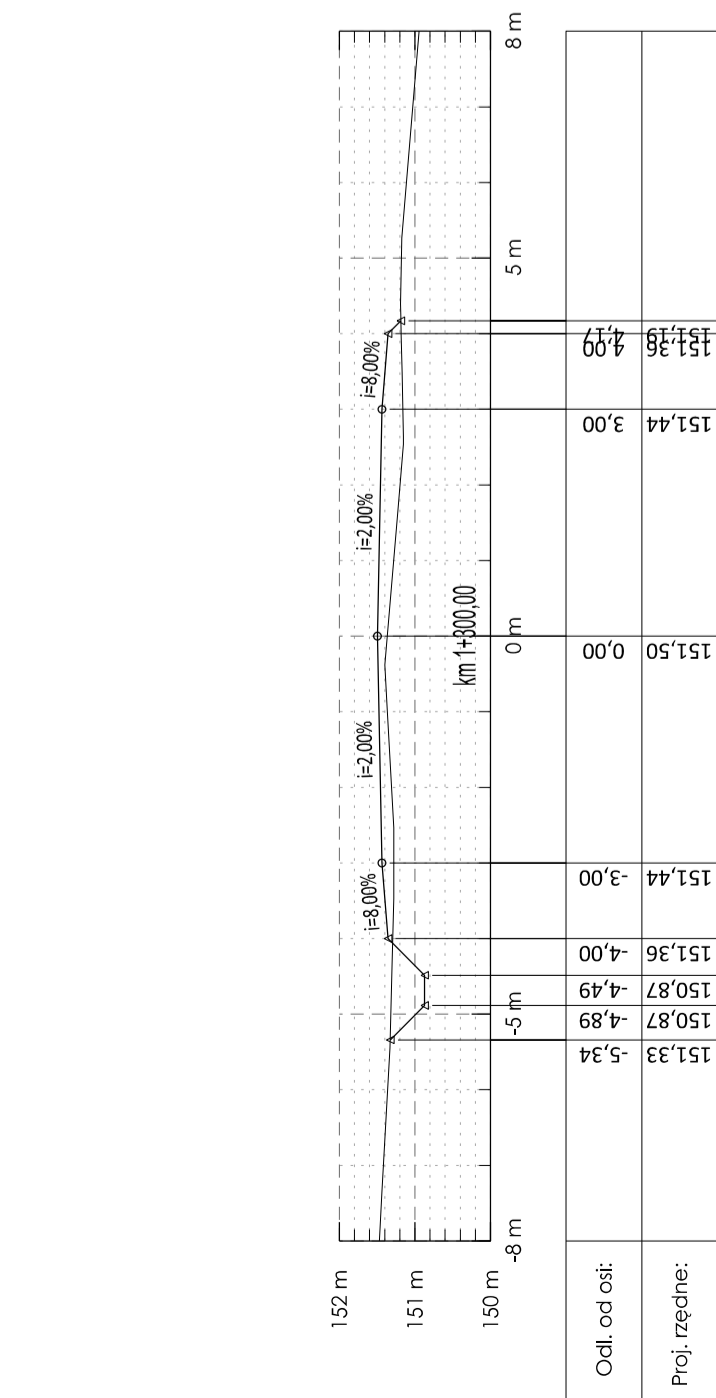
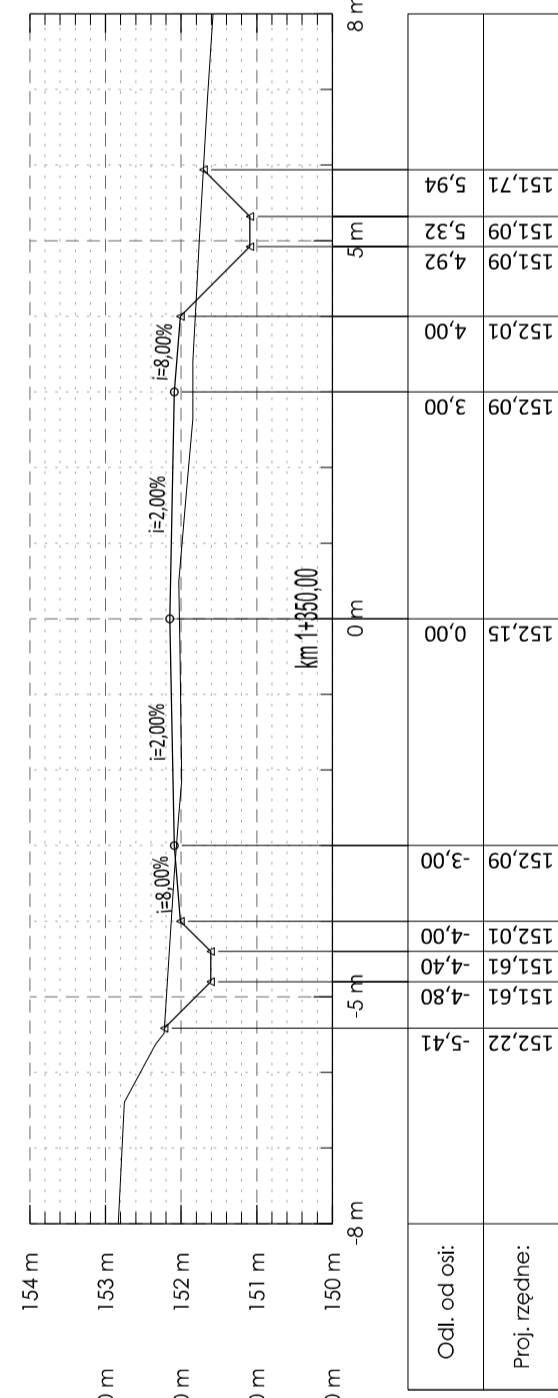
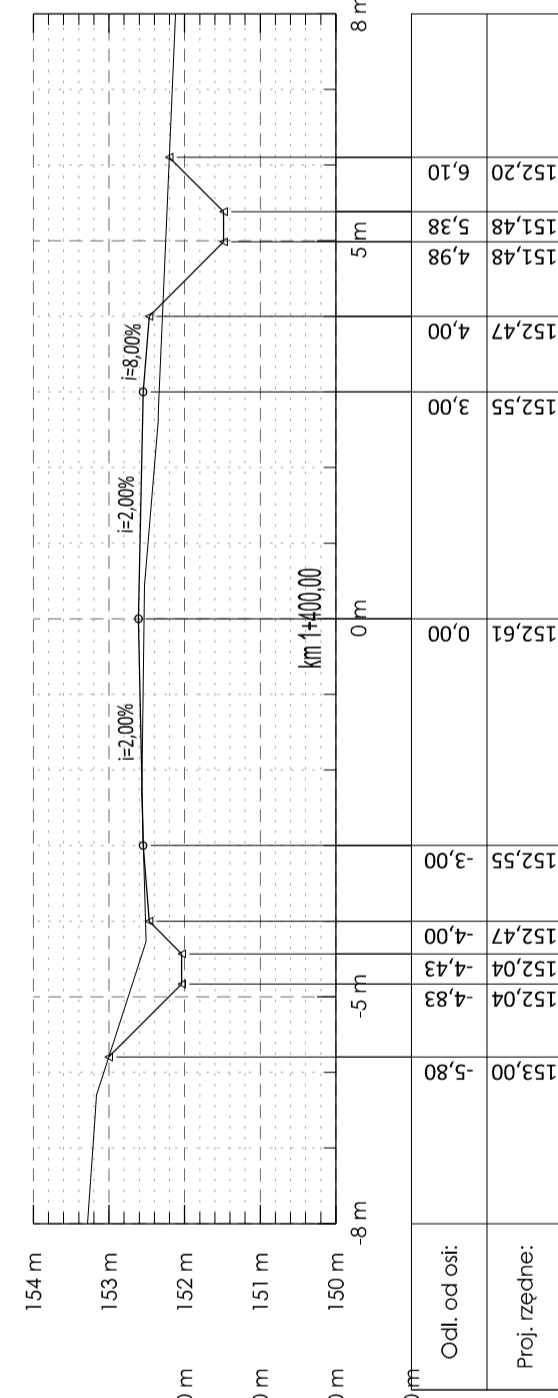
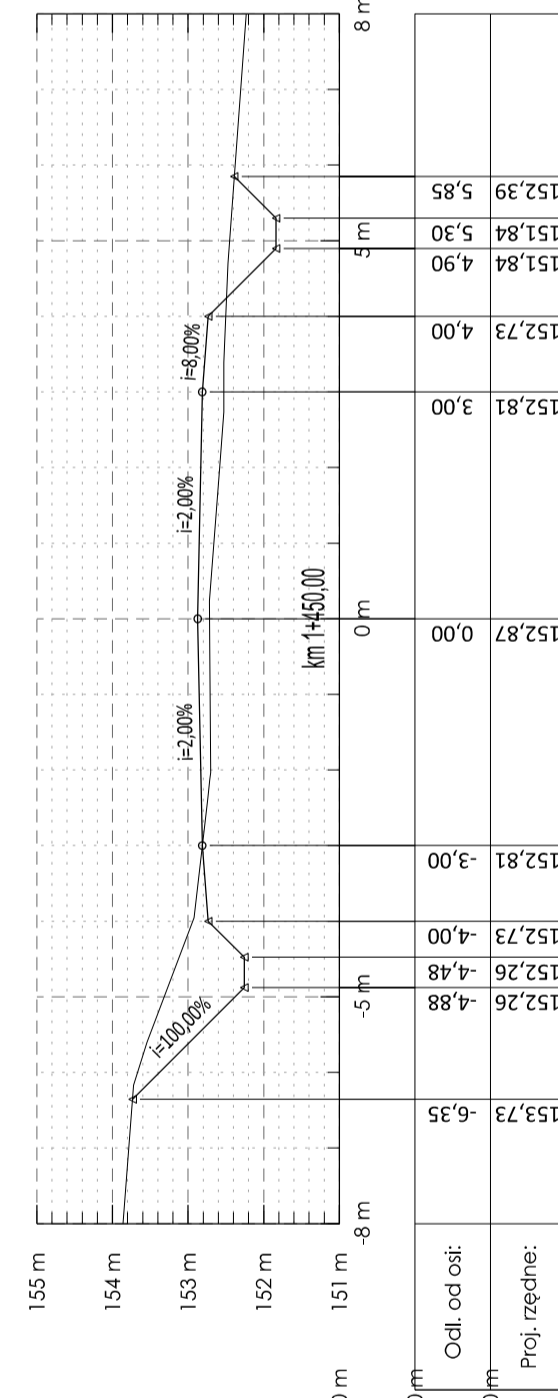
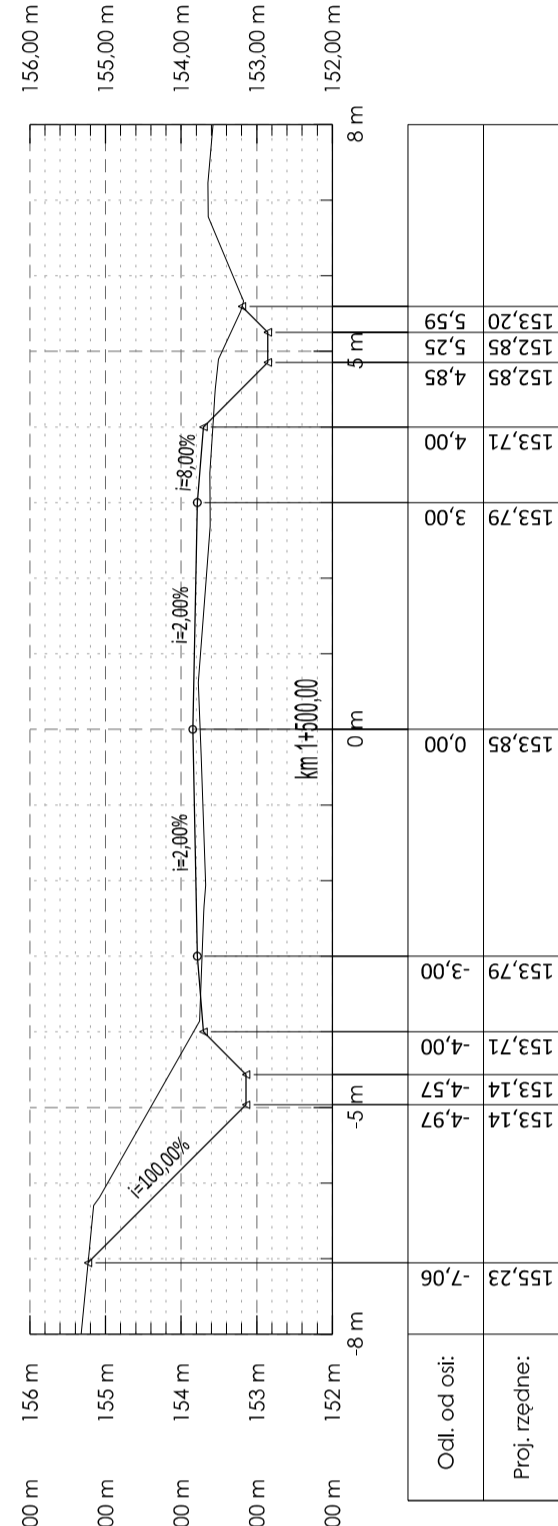
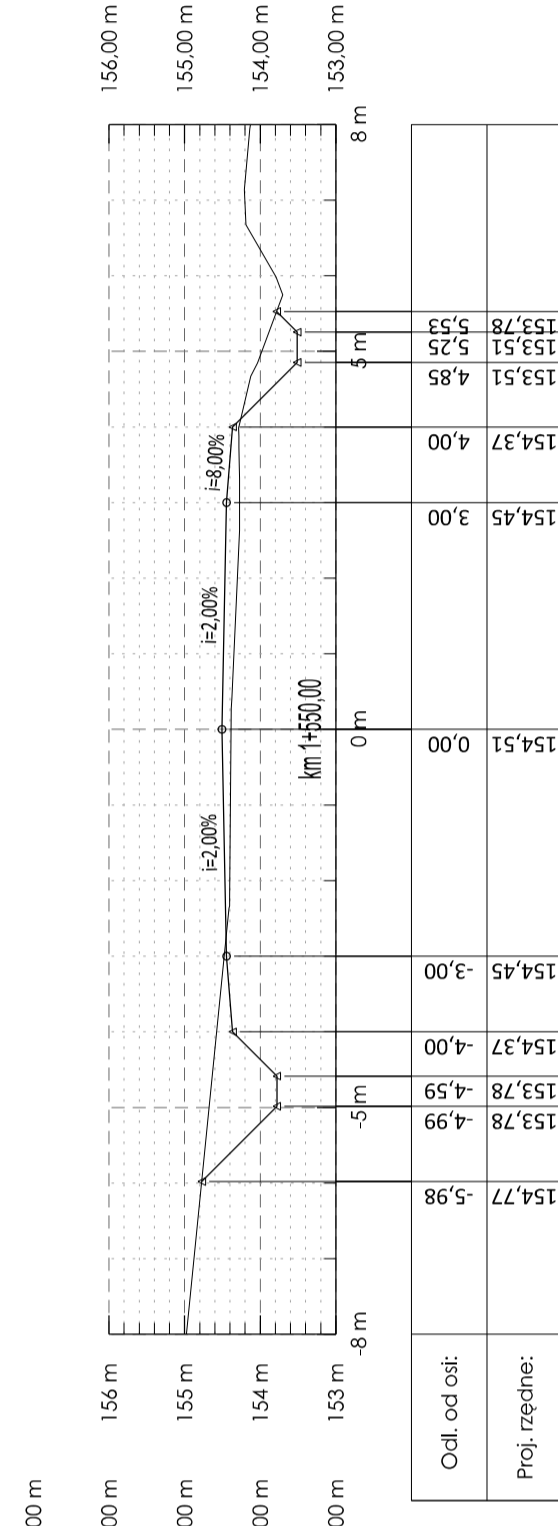
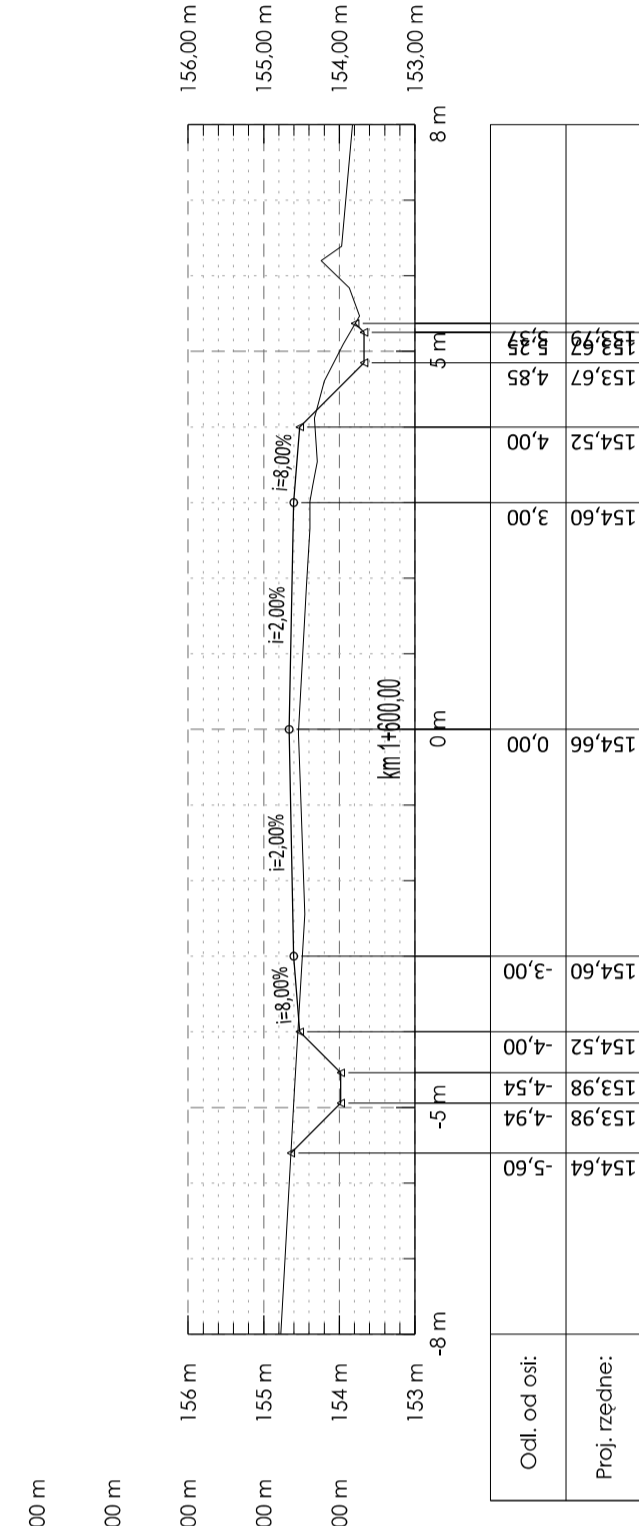

<p>Wykonawca:  Starostwo Powiatowe w Grojcu ul. Piłsudskiego 59 05-600 Grojce</p>	<p>Faza projektu: PROJEKT BUDOWLANO - WYKONAWCZY</p>	<p>Projektant: mgr inż. Krzysztof Suliga upr. nr 83/PO/S/12</p>	<p>Podpis: </p>
		<p>Sprawdzący: mgr inż. Bartłomiej Małęcka upr. nr MIAZ/0405/PO00/10</p>	<p>Podpis: </p>
		<p>Tom: TOM-I</p>	<p>Data: VIII.2017</p>
		<p>Skala rysunku: 1:50</p>	<p>Nr rysunku: PC-1602-05</p>
<p>Przebieg: PRZEBUDOWA DRÓG POWIATOWYCH NR 1602W WILCZORUDA - MICHROW I 1601W PNIĘWY - REMBERTÓW</p>		<p>Przebieg rysunku: Przebieg charakterystyczny</p>	

od km 1+650,00 - do km 2+050,00

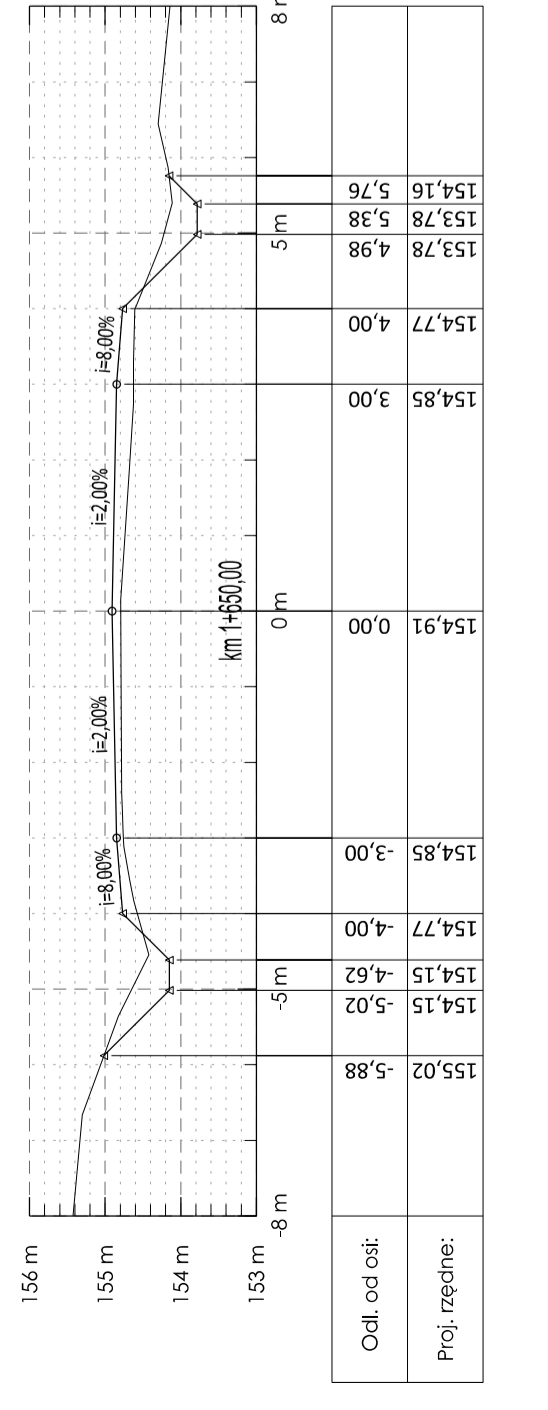
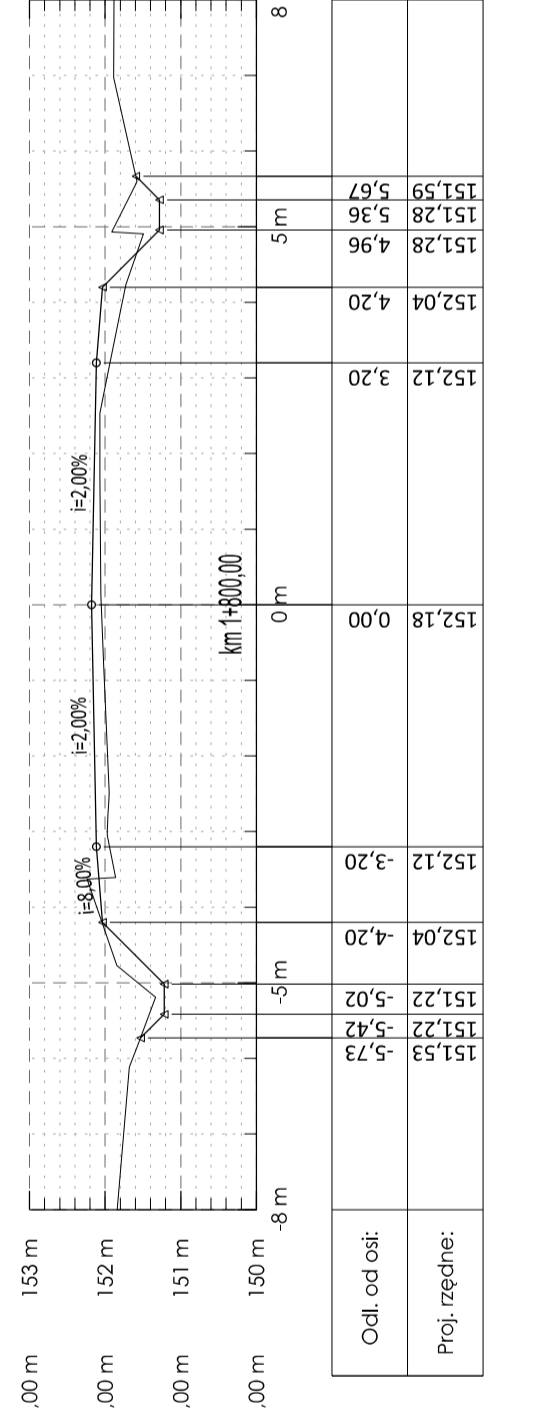
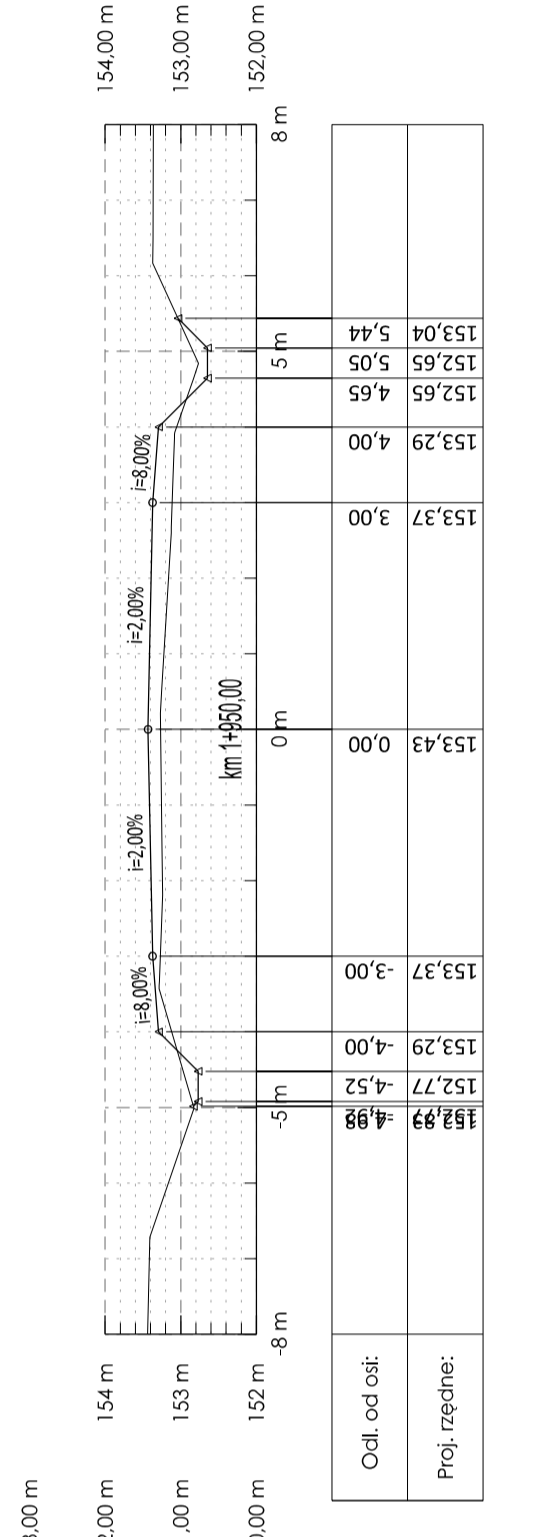
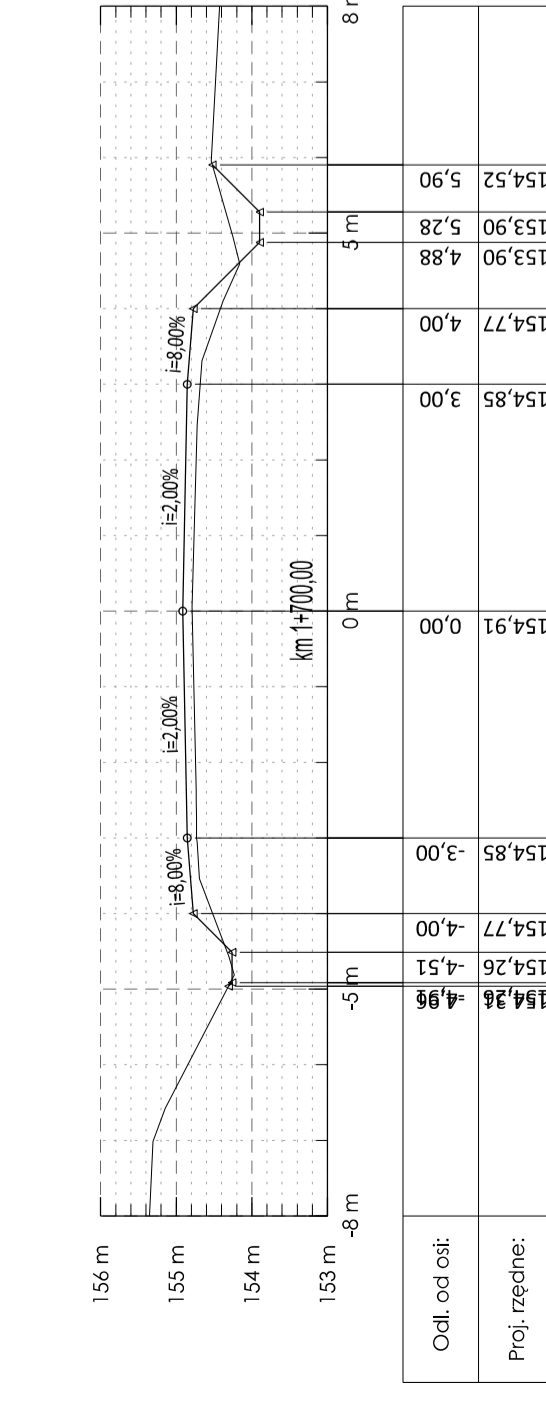
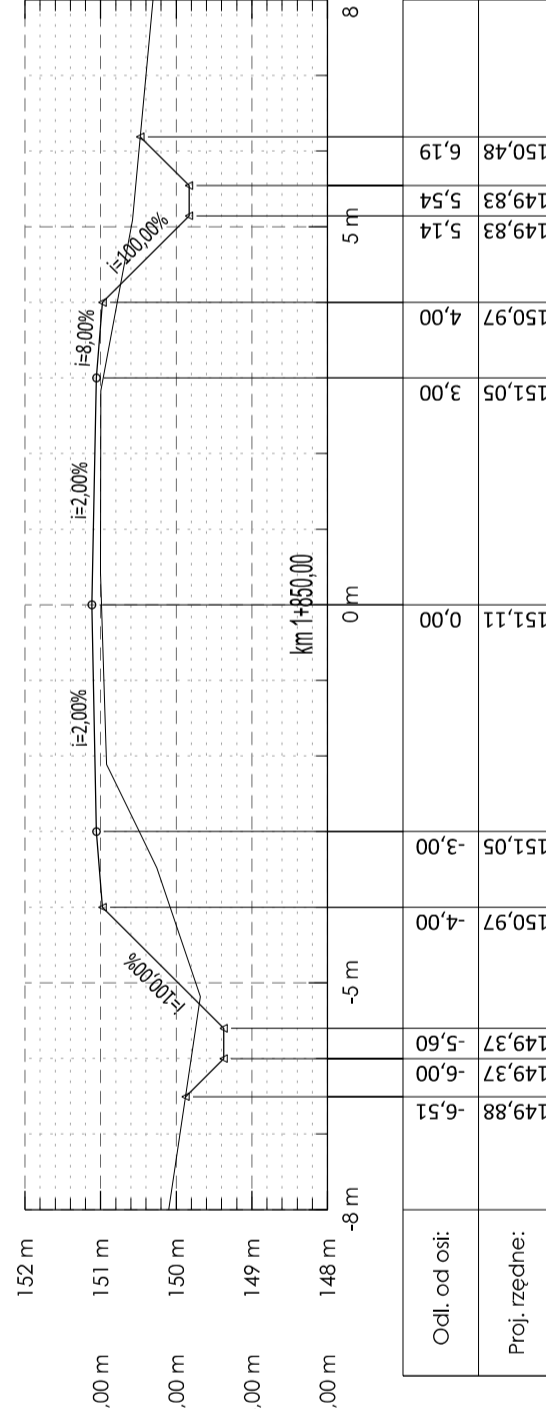
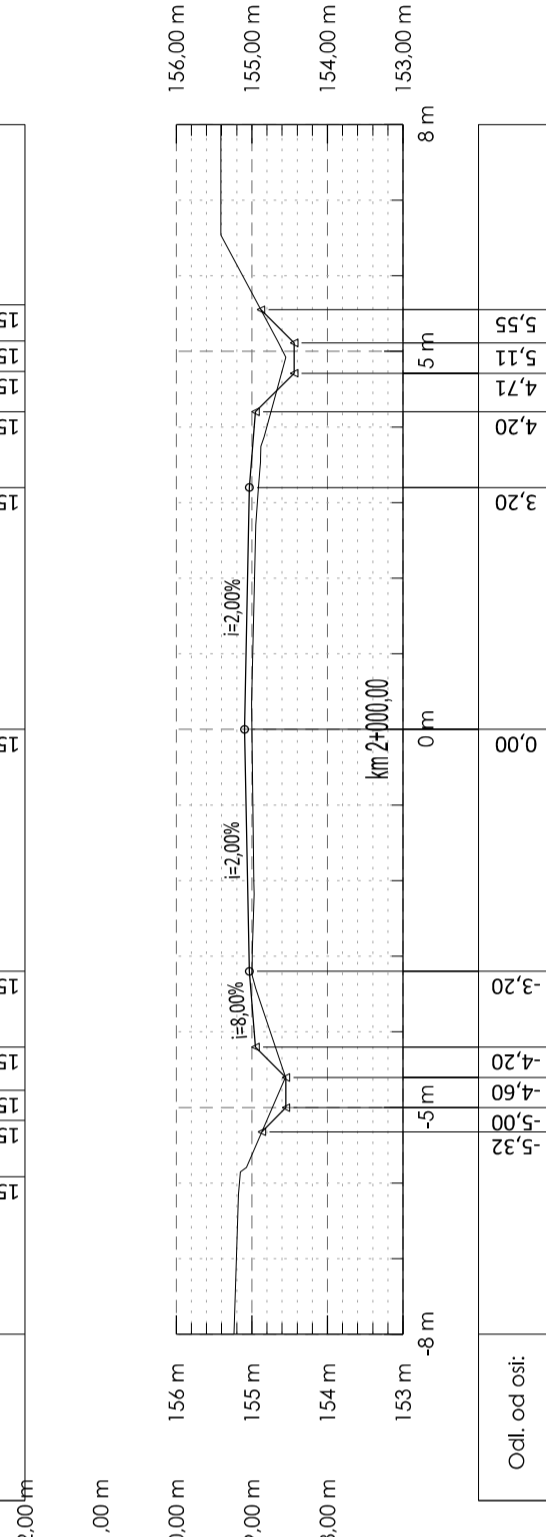
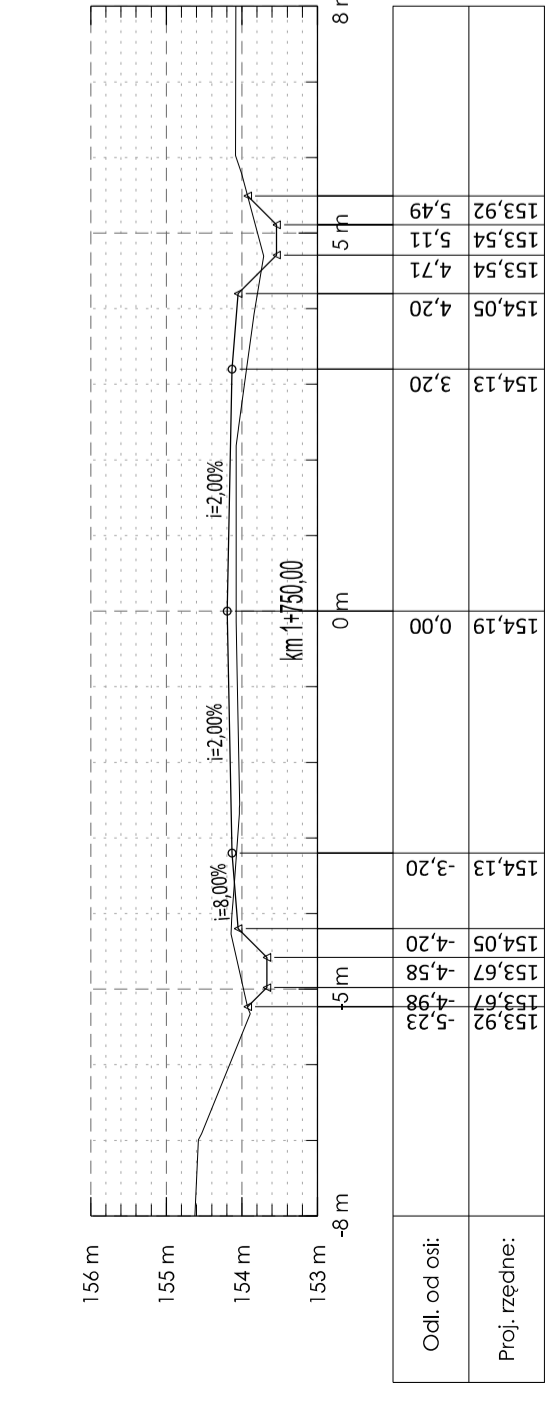
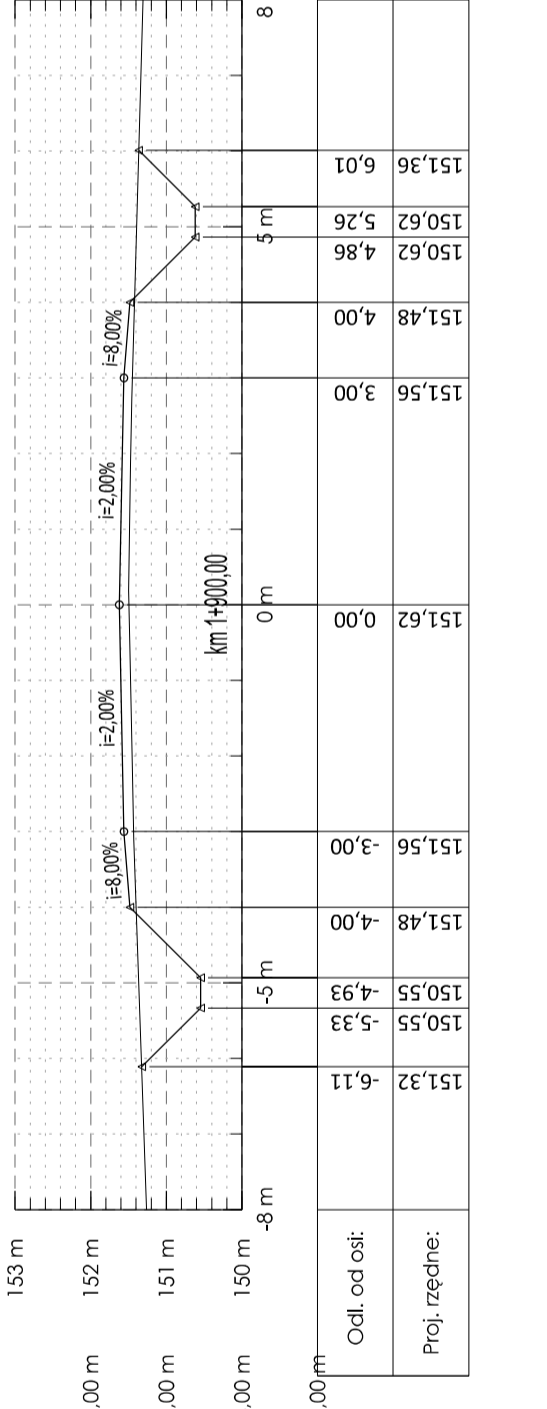
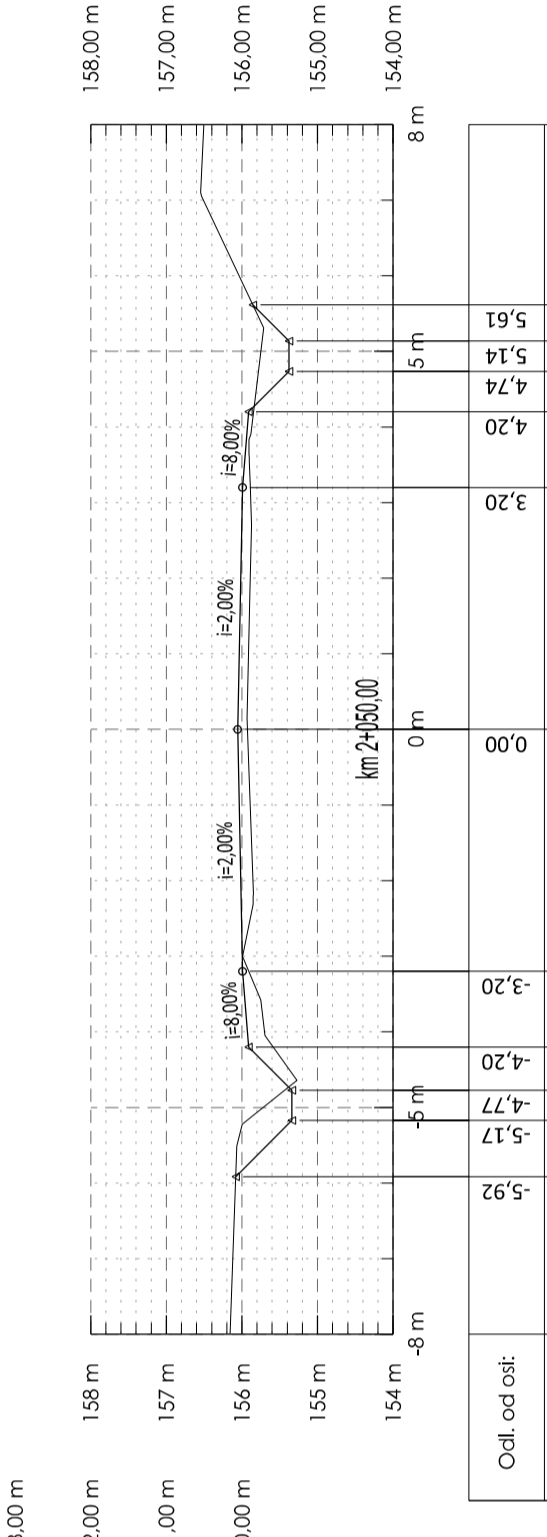

Inwestor: Starostwo Powiatowe w Grójcu
ul. Piłsudskiego 59
05-600 Grójec

Wykonawca: BPI
Biurowy Projektów Infrastrukturalnych
ul. Teczowa 3/6, 05-270 Marki
tel. 791 95 53, email: biuro@bpi-ka.pl

Faza projektu: PROJEKT BUDOWLANO - WYKONAWCZY

Inżynieria ruchu: mgr inż. Krzysztof Suliga
upr. nr 83/PDS/12

Sprawdzający: mgr inż. Bartłomiej Małętka
upr. nr MAZ/0405/POD/10

Tom: TOM-I

Skala rysunku: 1:50

Data: VIII.2017

Tytuł rysunku: Przekroje charakterystyczne

Nr rysunku: PC-1602-06

od km 2+332,95 - do km 2+550,00

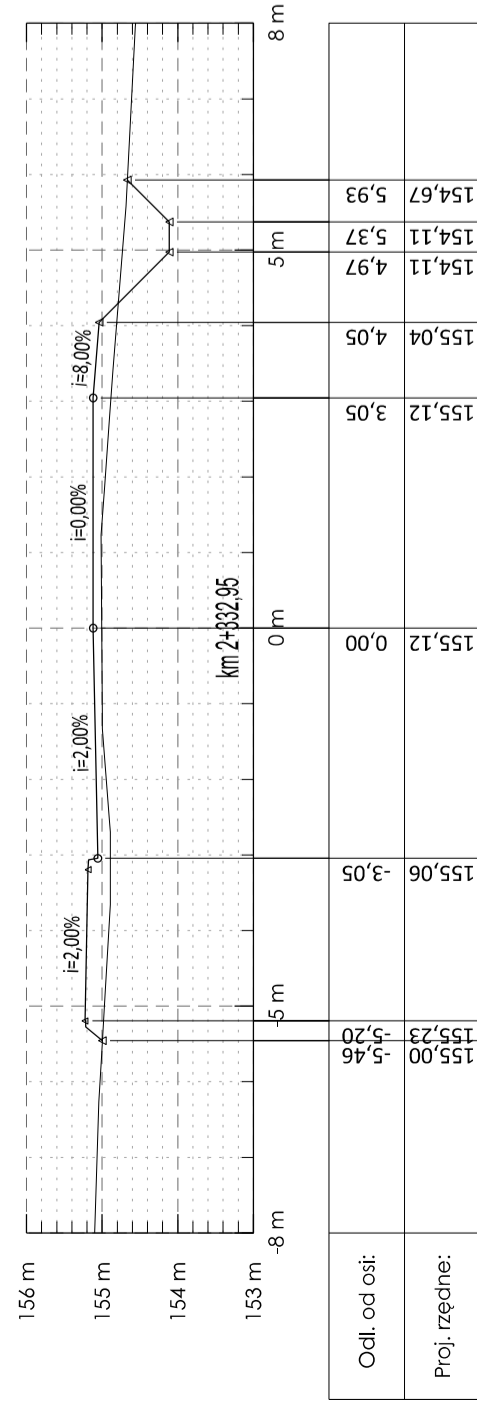
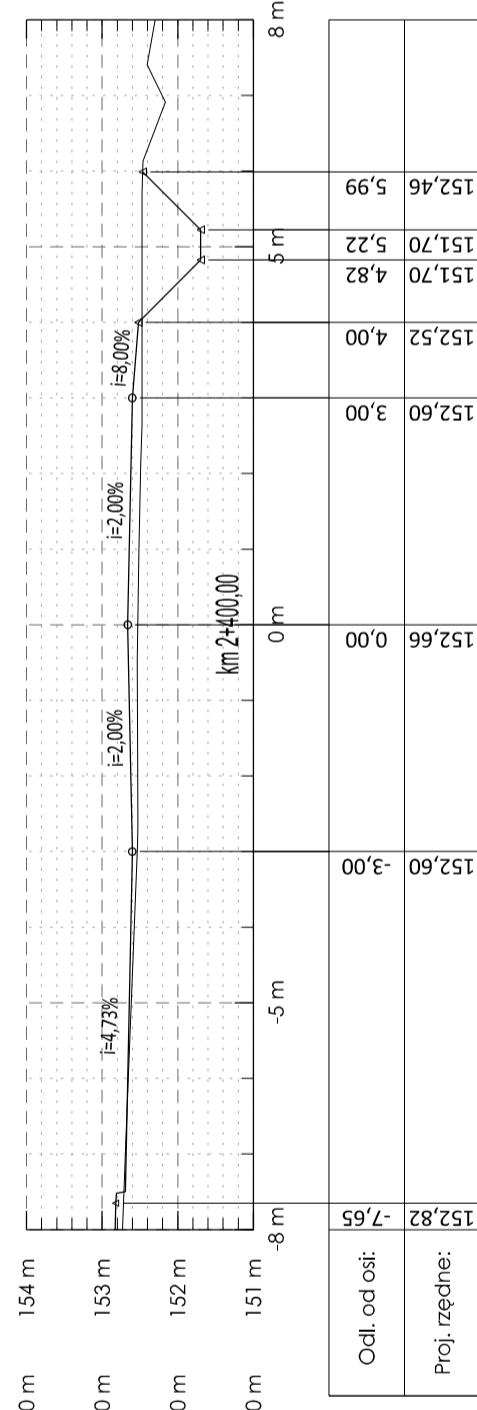
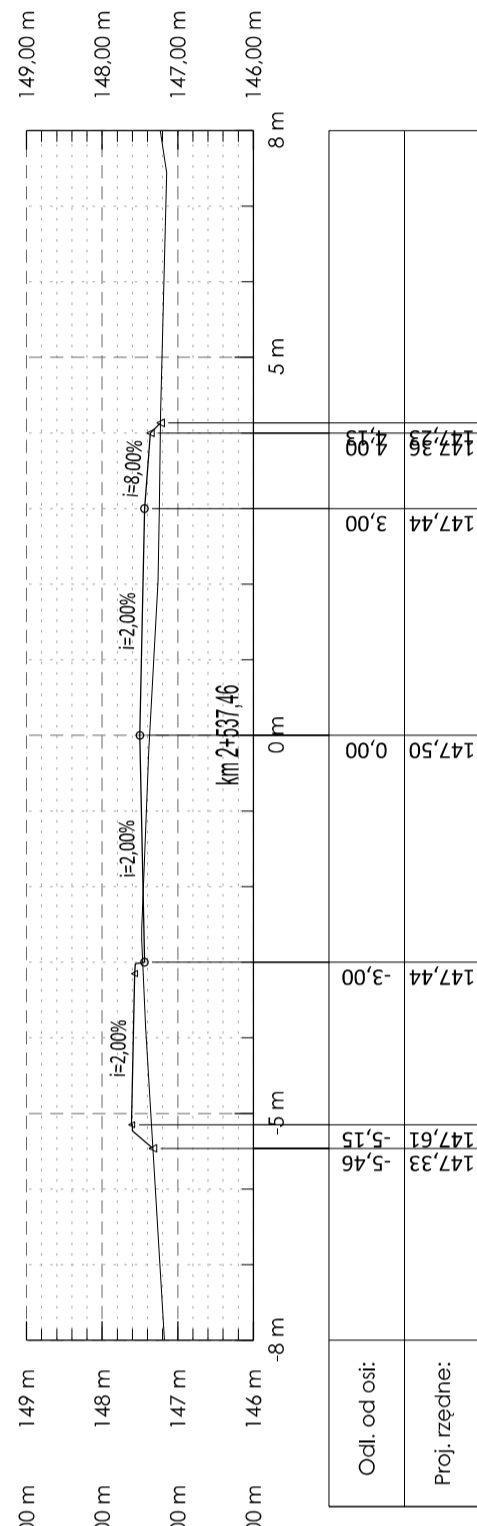
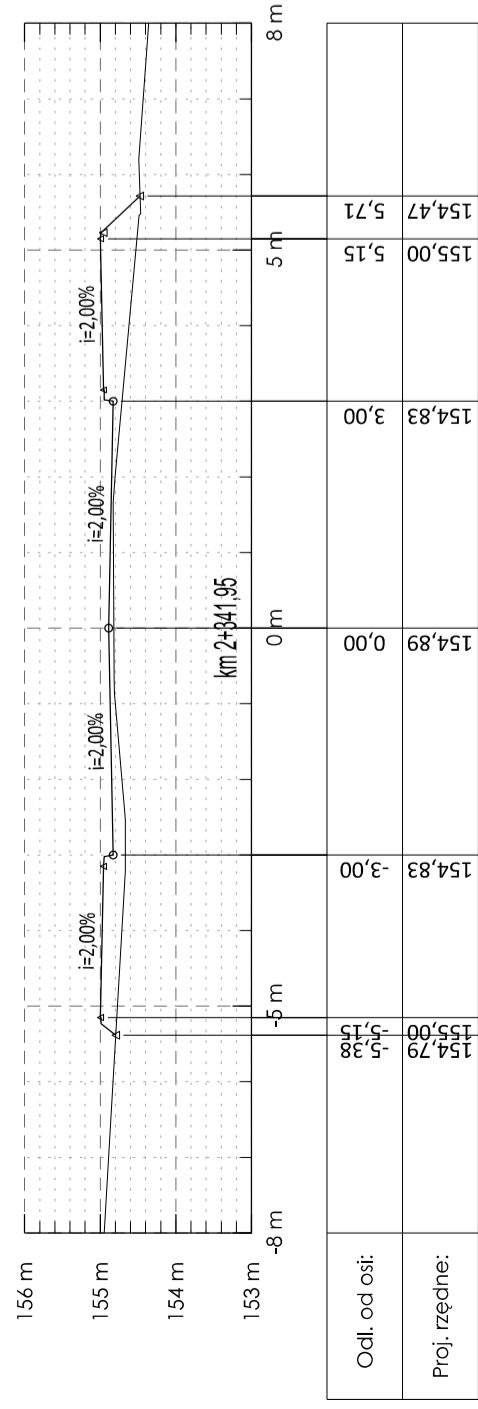
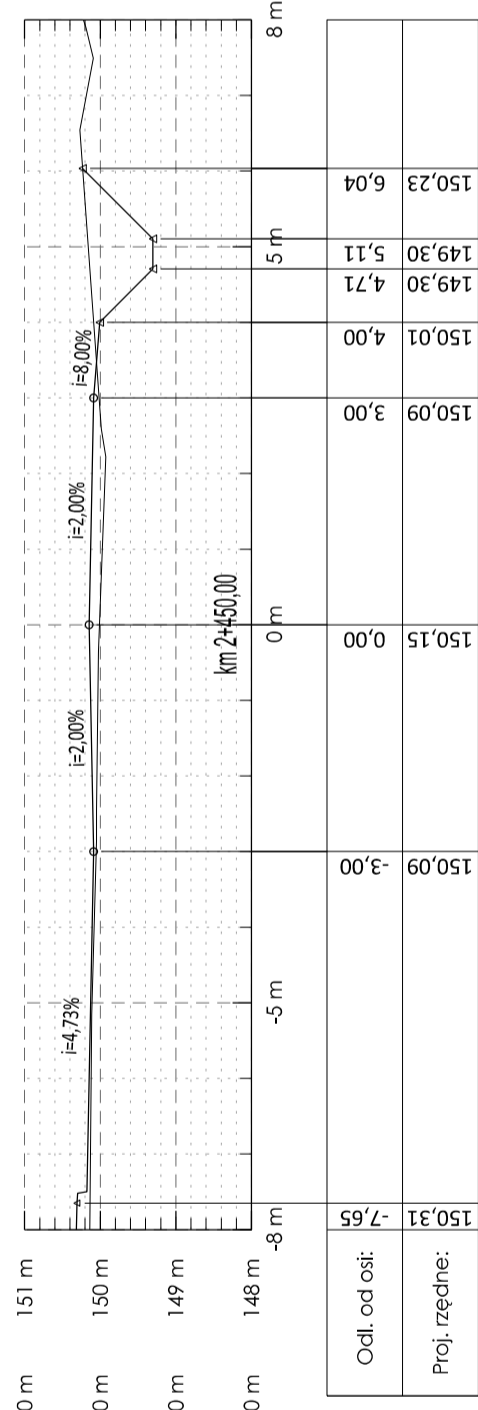
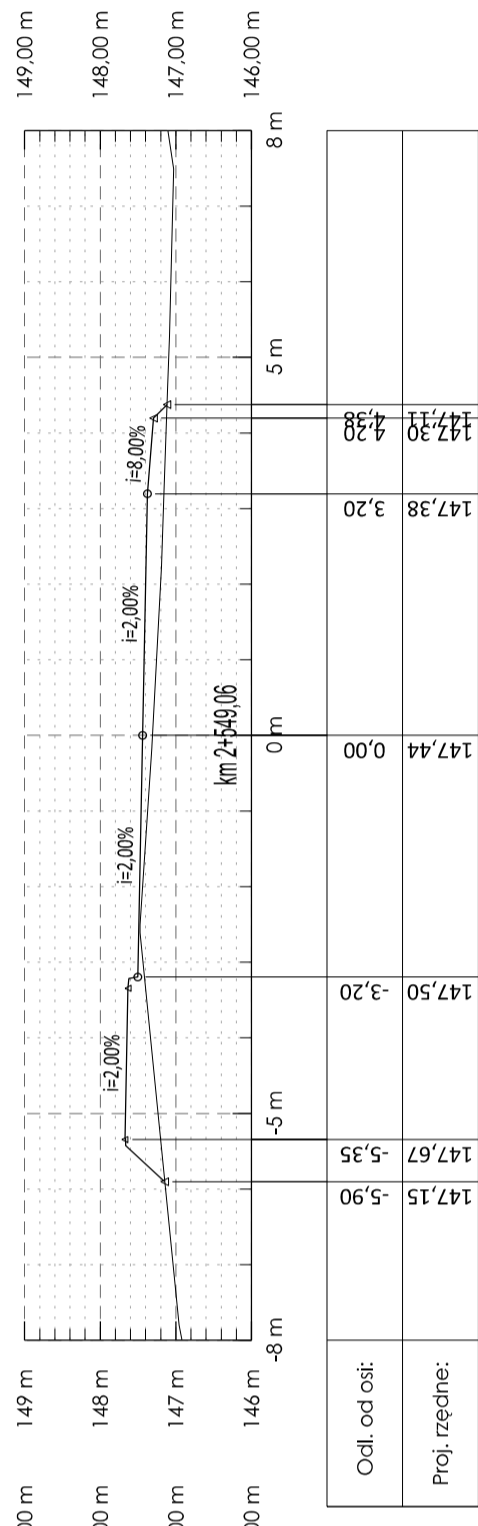
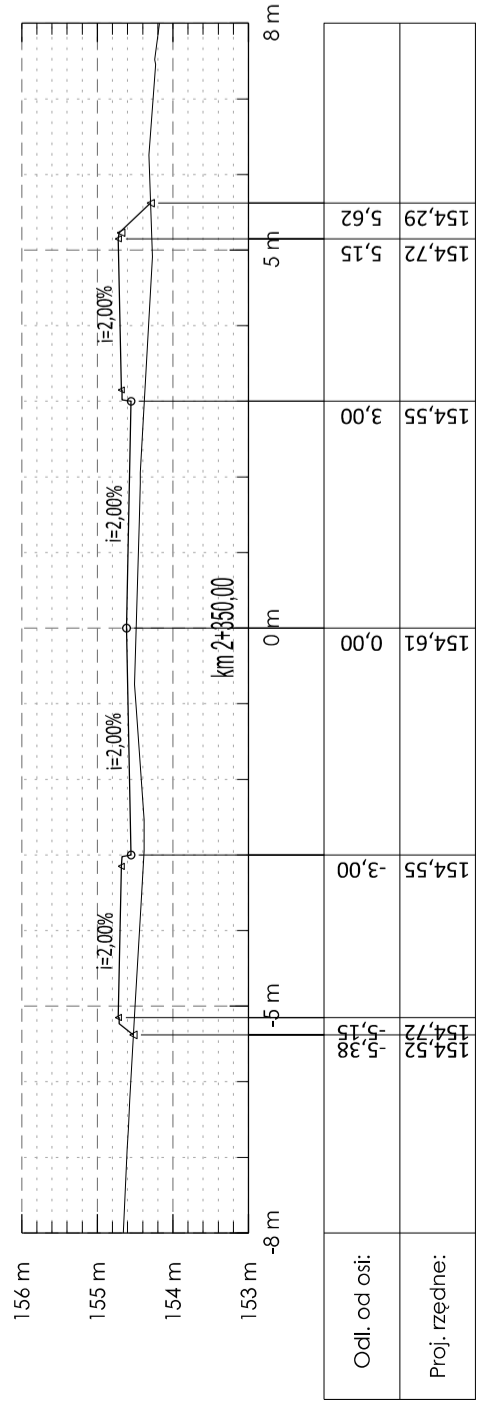
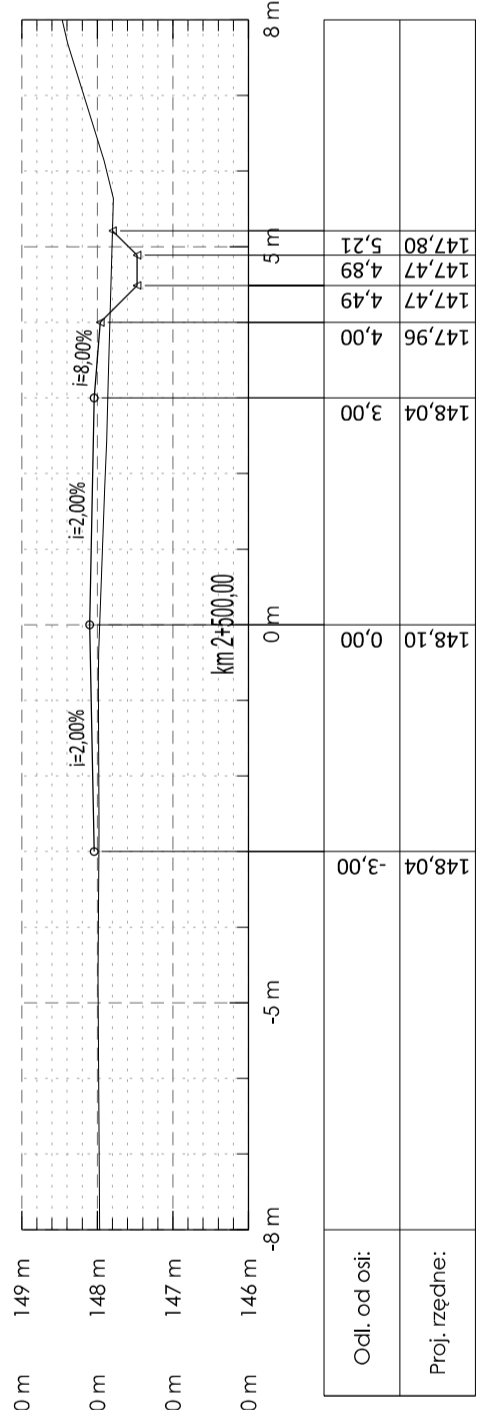
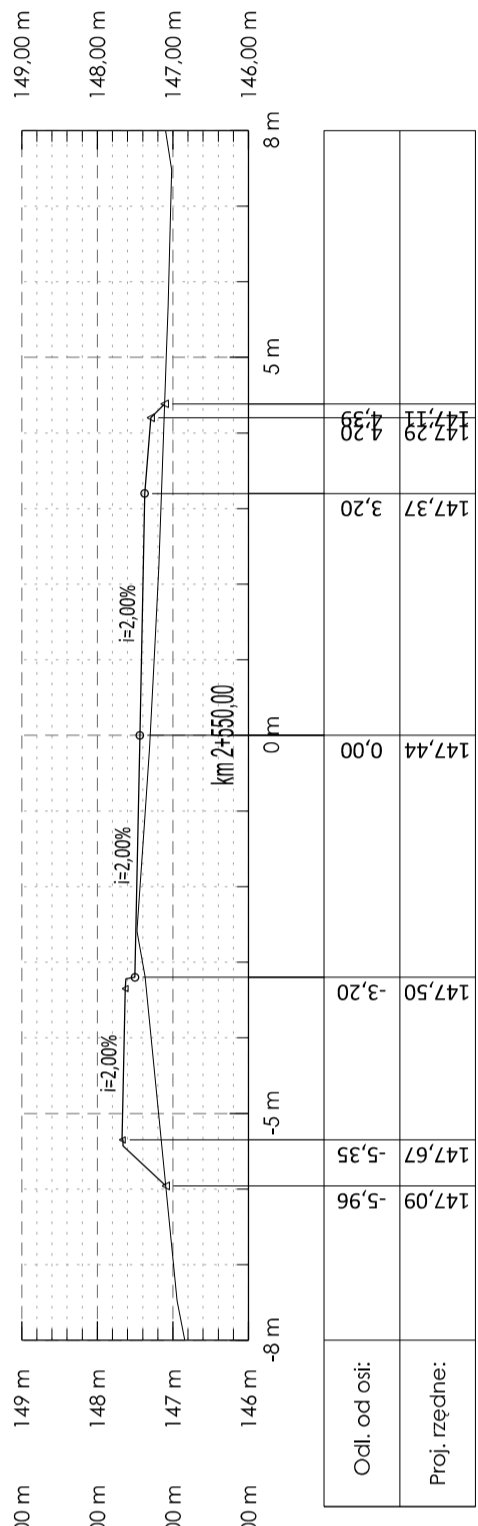

 Starostwo Powiatowe w Grojcu ul. Piłsudskiego 59 05-600 Grojec	Faza projektu: PROJEKT BUDOWLANO - WYKONAWCZY Inwestor:
Wykonawca: Biuro Projektów Infrastrukturalnych Krzysztof Suliga, ul. Teczowa 3/6, 05-270 Marki tel. 791 95 65 51, email: biuro@bpi-ke.pl	Projektant: mgr inż. Krzysztof Suliga upr. nr 63/PO/S/12 Podpis:
Sprawdzający: mgr inż. Bartłomiej Małętka upr. nr 1042/04/05/PO/07/10 Podpis:	Data: VIII.2017
Tom: TOM-I	Skala rysunku: 1:50
Tytuł rysunku: Przekroje charakterystyczne	Nr rysunku: PC-1602-08

od km 2+588,75 - do km 2+710,00

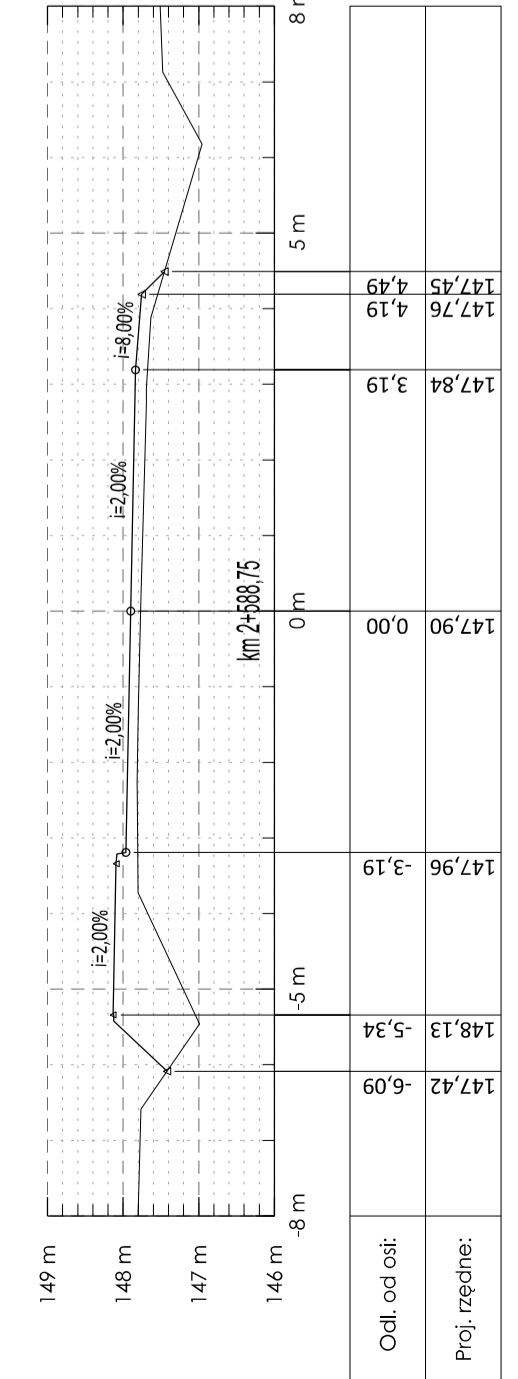
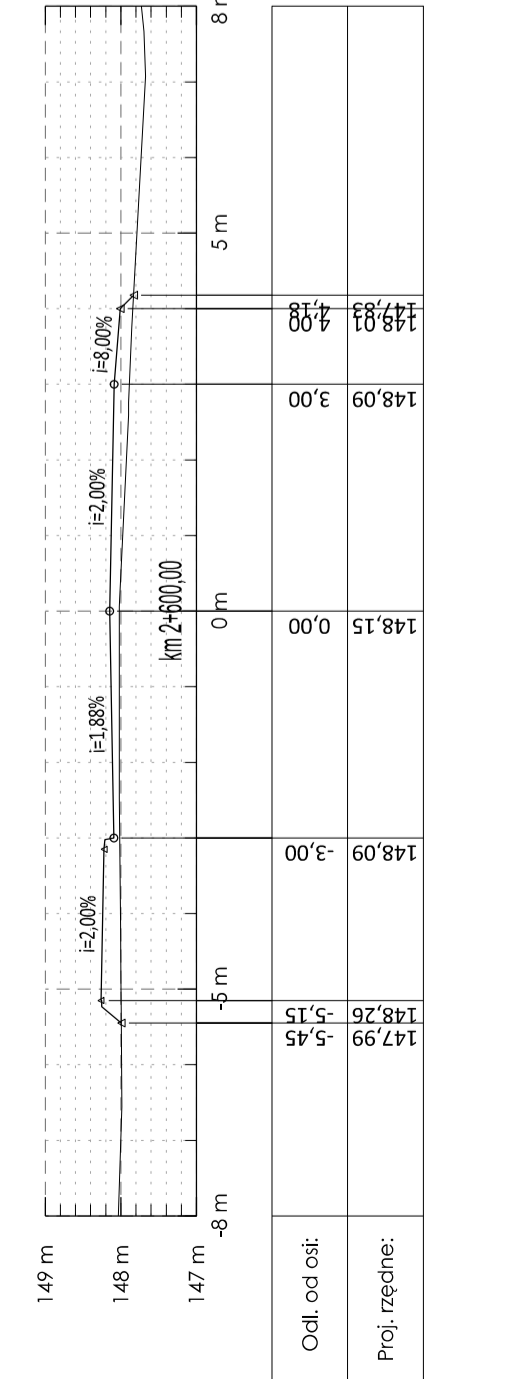
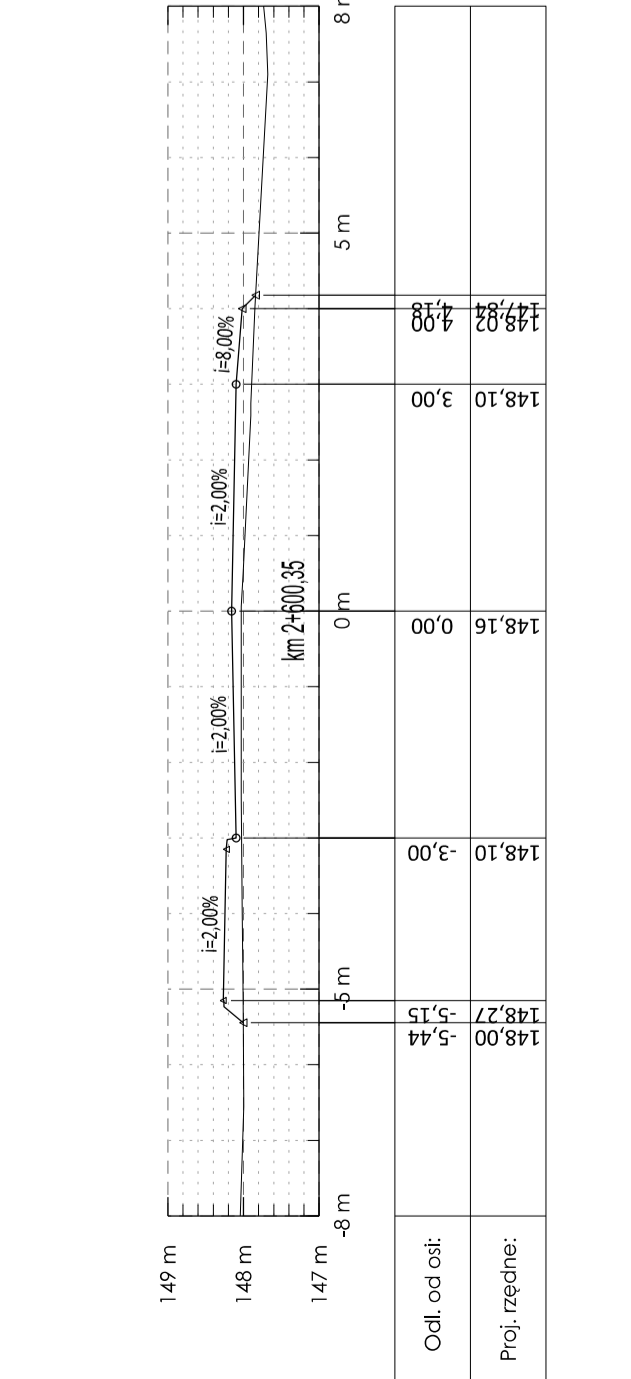
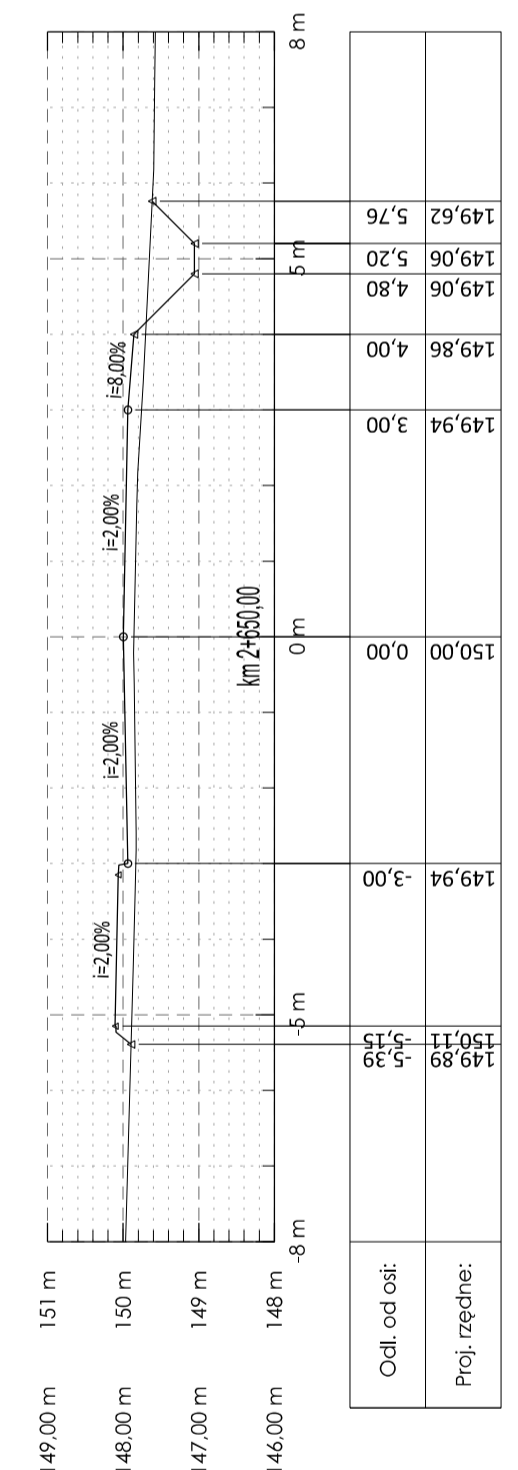
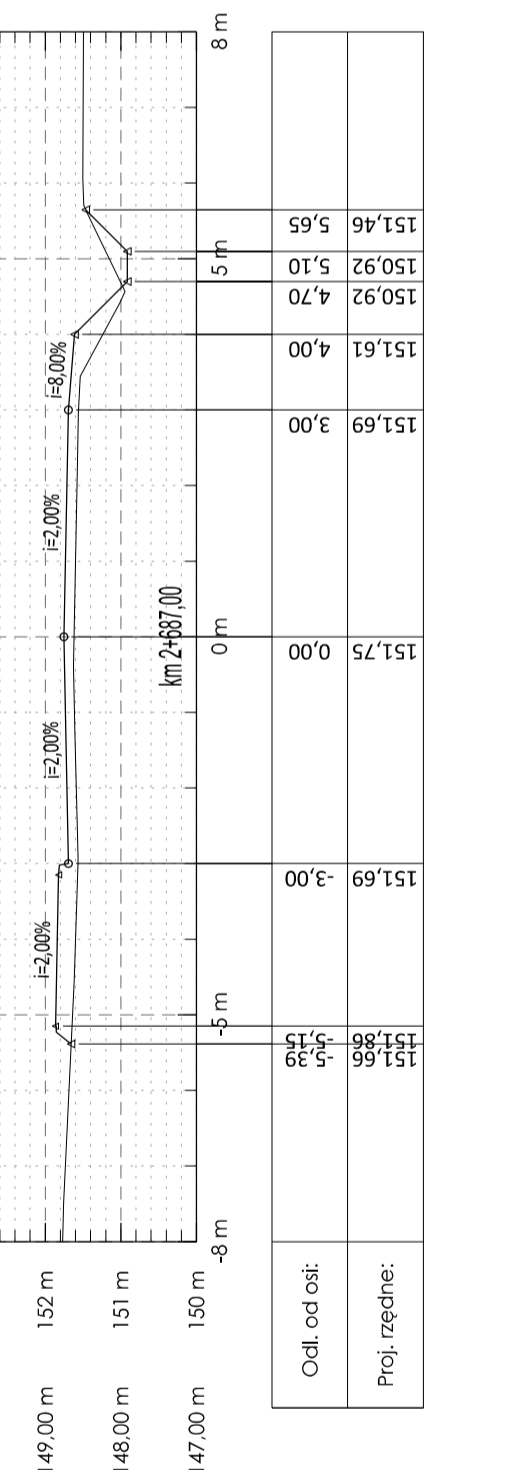
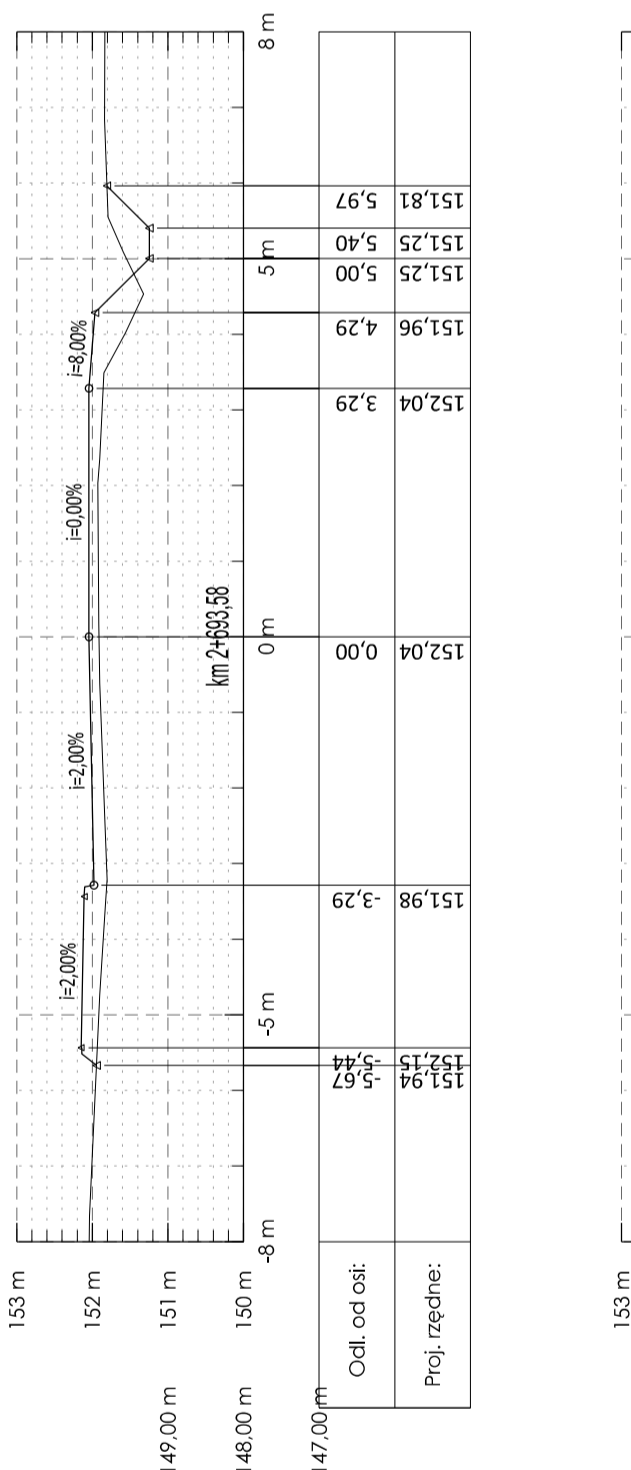
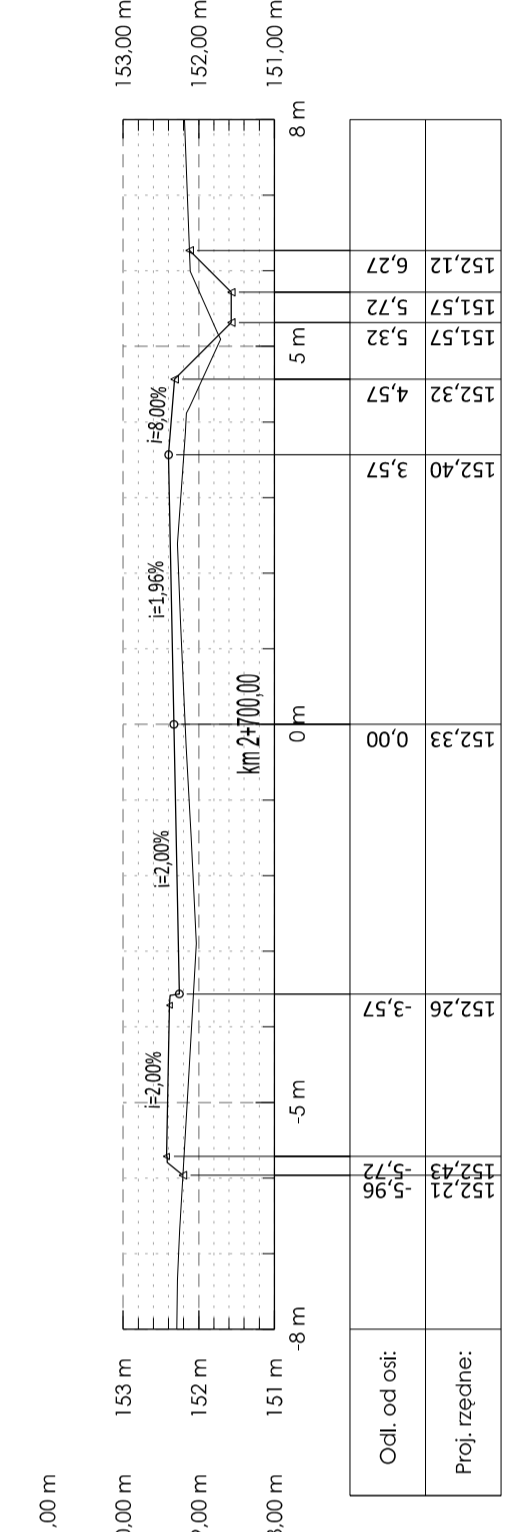
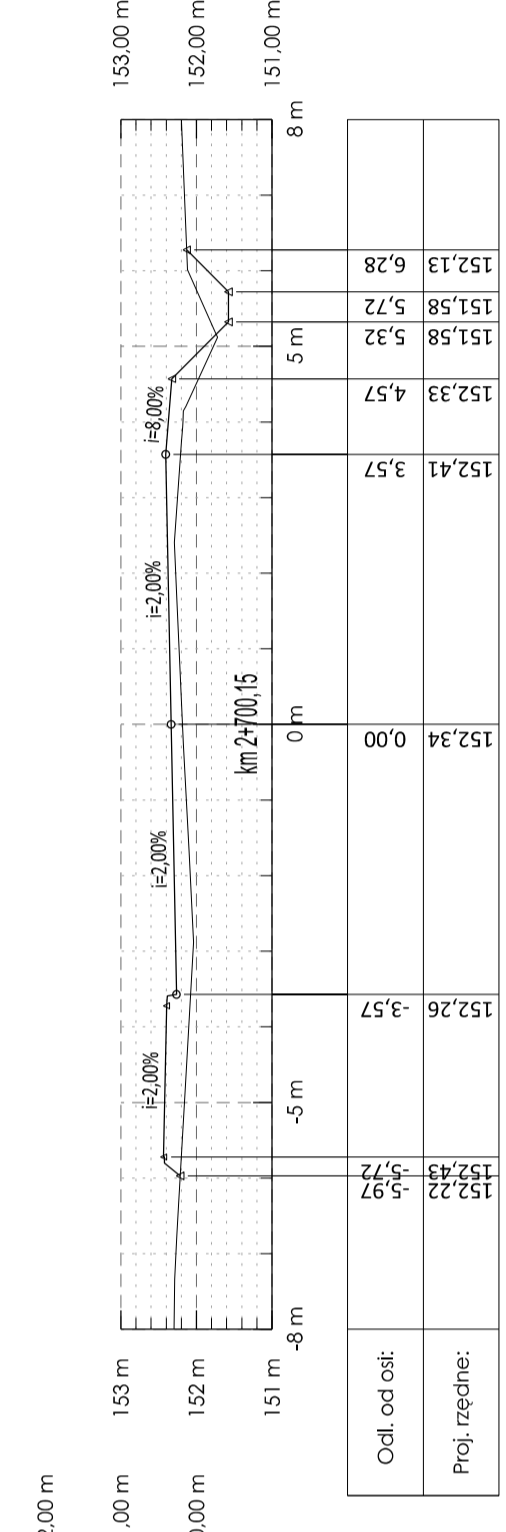
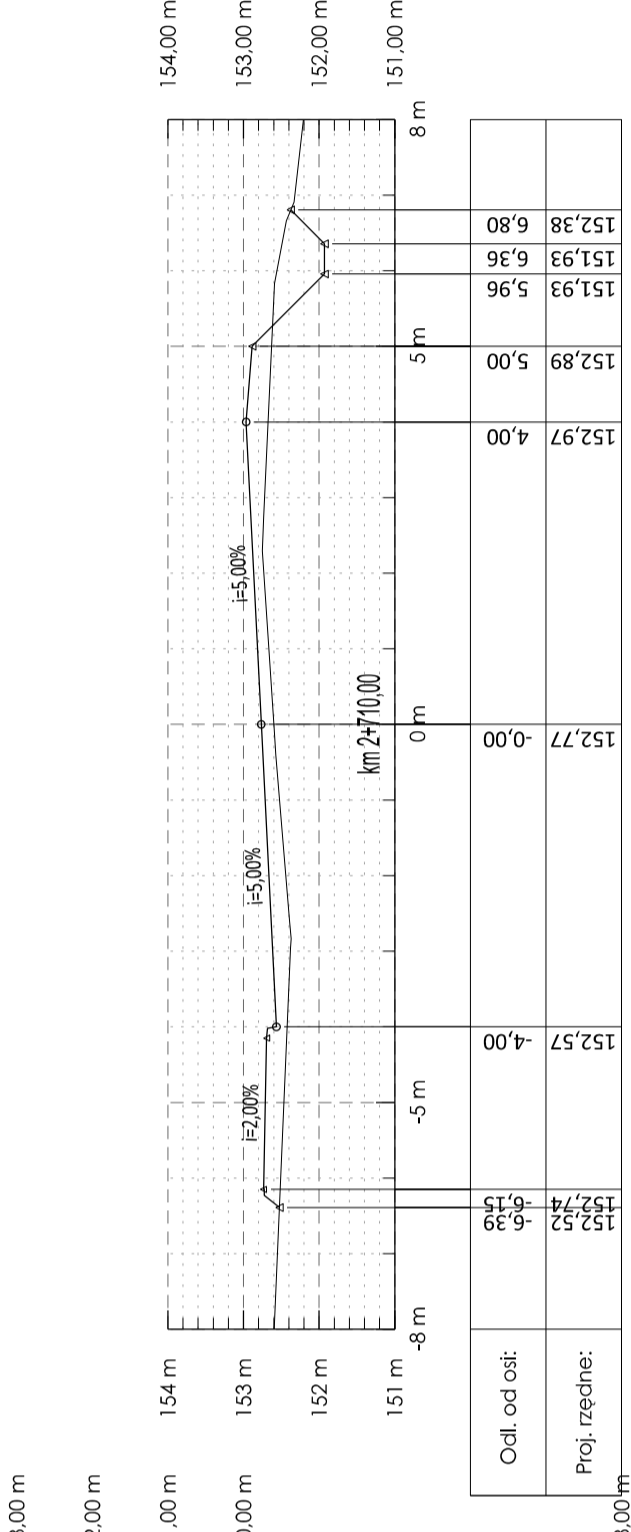

Inwestor:  **Starostwo Powiatowe w Grojcu**
ul. Piłsudskiego 59
05-600 Grojec

Wykonawca: **BPI**
Biuro Projektów Infrastrukturalnych
Krysztof Suliga, ul. Teczowa 3/6, 05-270 Marki
tel. 791 95 65 51, email: biuro@bpi-ko.pl

Faza projektu: PROJEKT BUDOWLANO - WYKONAWCZY

Inżynieria ruchu: mgr inż. Krzysztof Suliga
upr. nr 63/PO/S/12
Podpis: 



Sprawdzający: mgr inż. Bartłomiej Małętka
upr. nr MAZ/0405/POD/10
Podpis: 

Tom: TOM-I
Skala rysunku: 1:50
Data: VIII.2017

Typul rysunku: Przekroje charakterystyczne
Nr rysunku: PC-1602-09

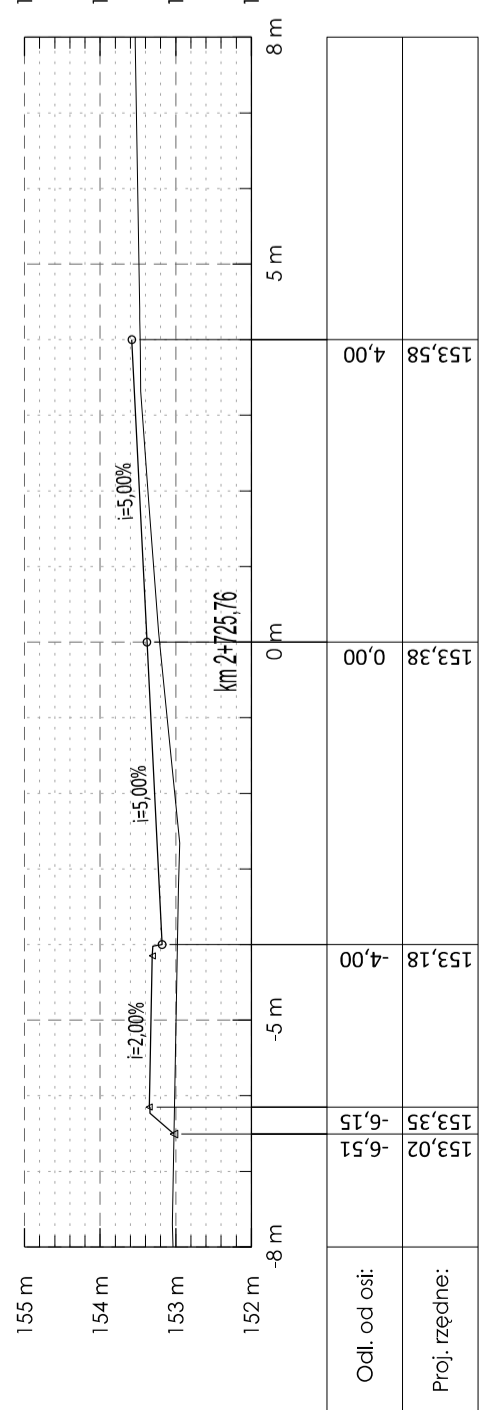
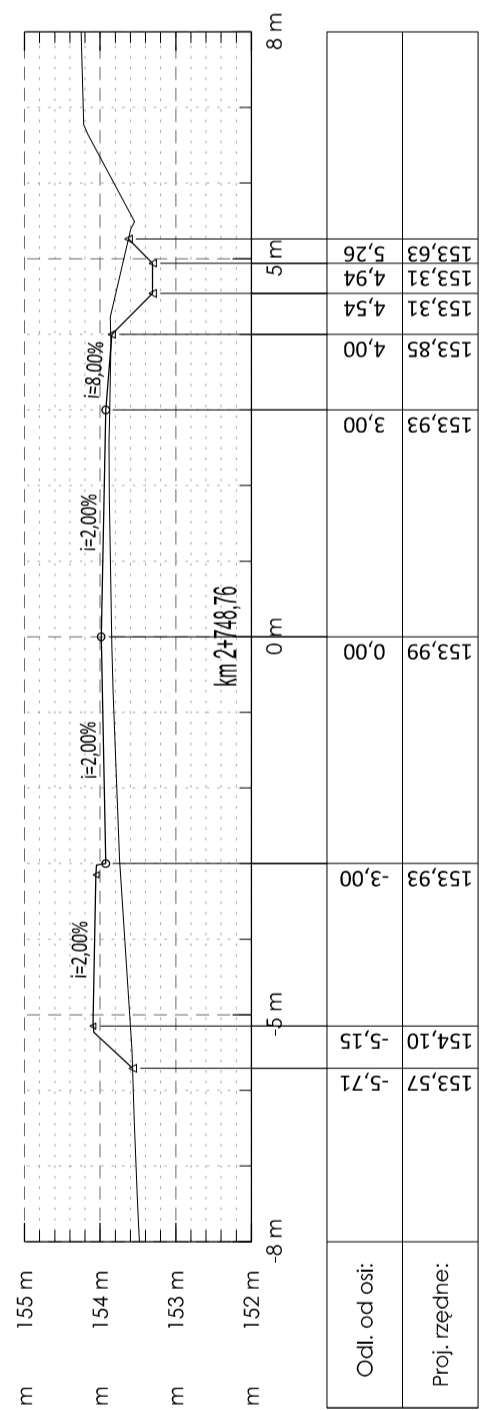
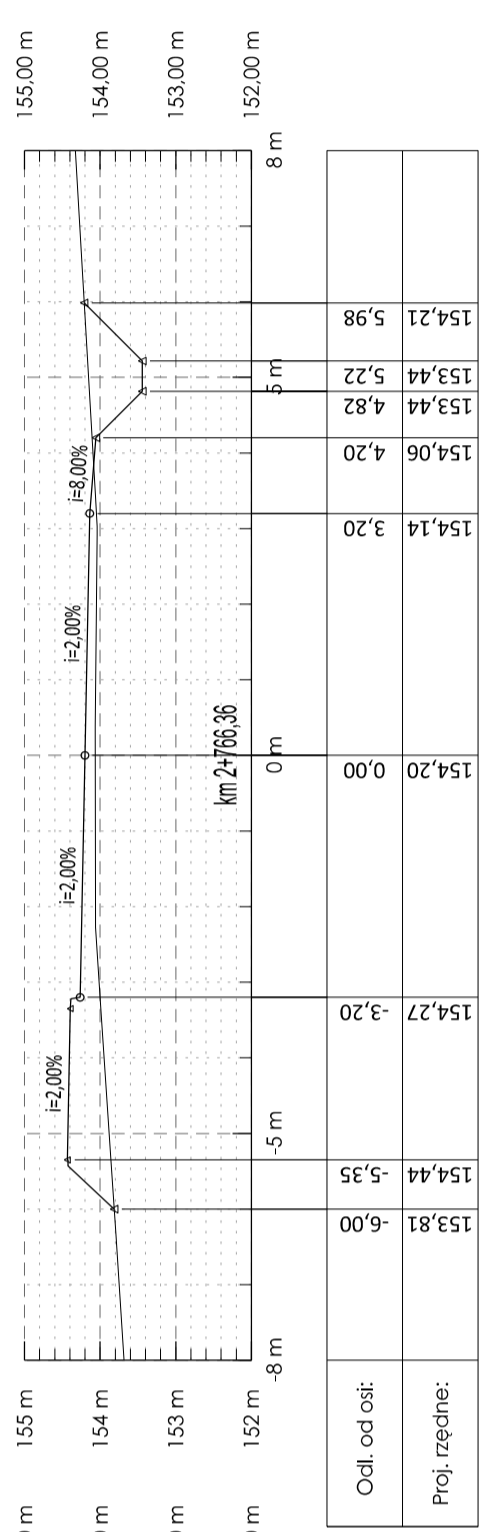
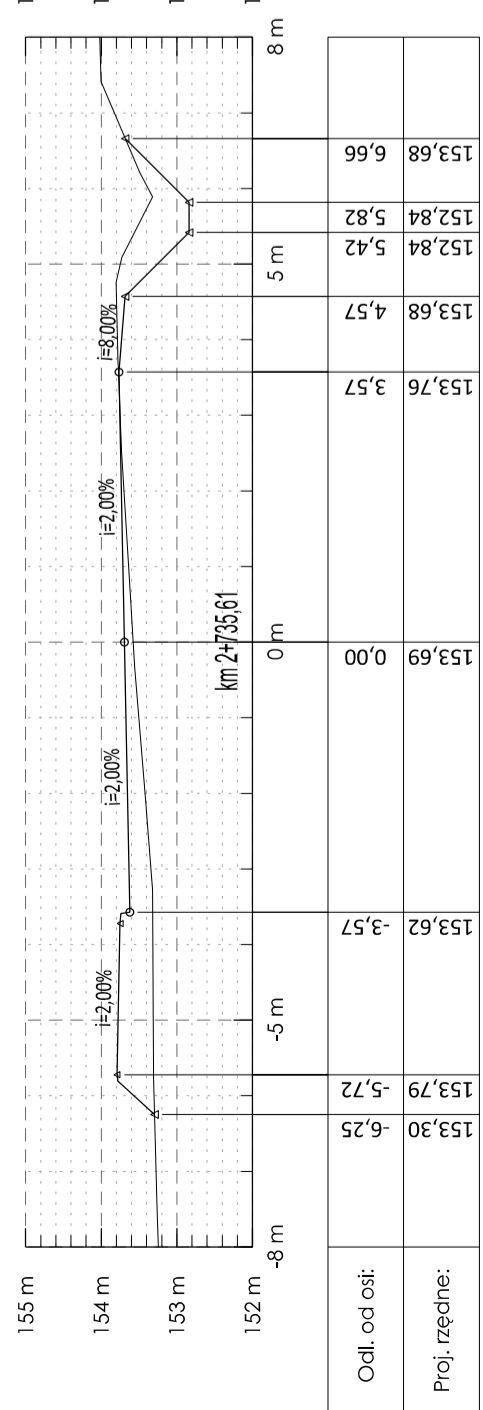
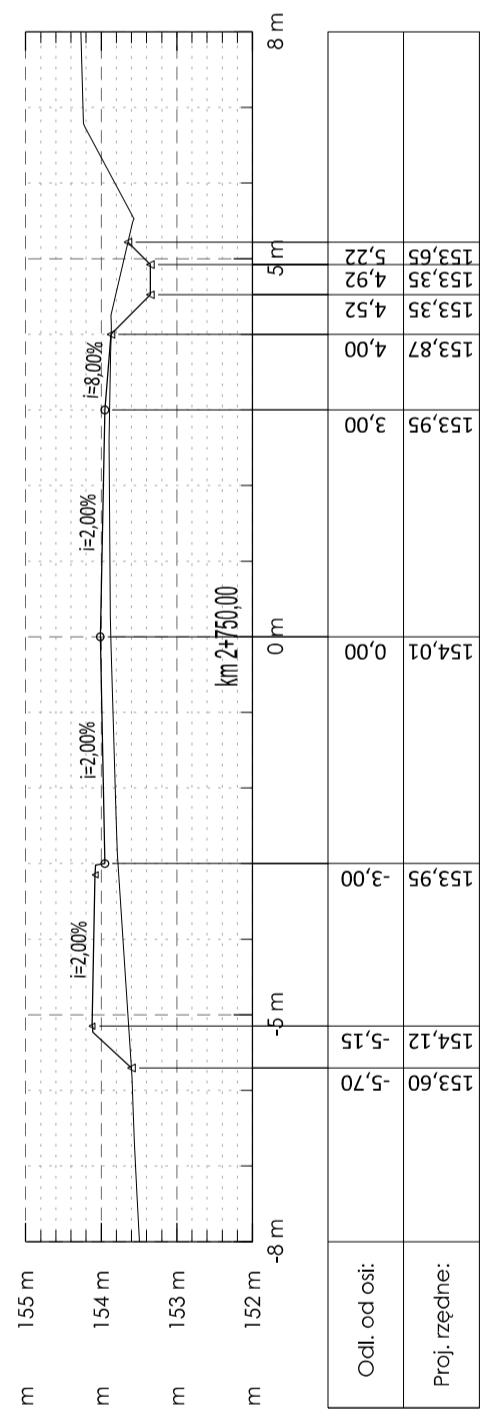
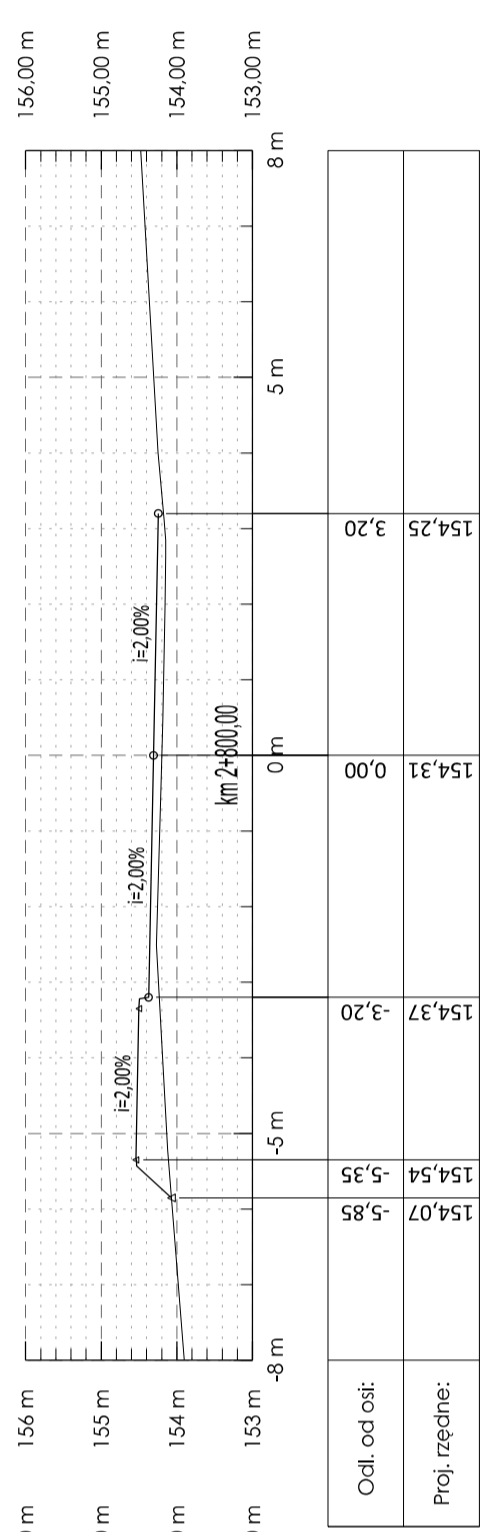
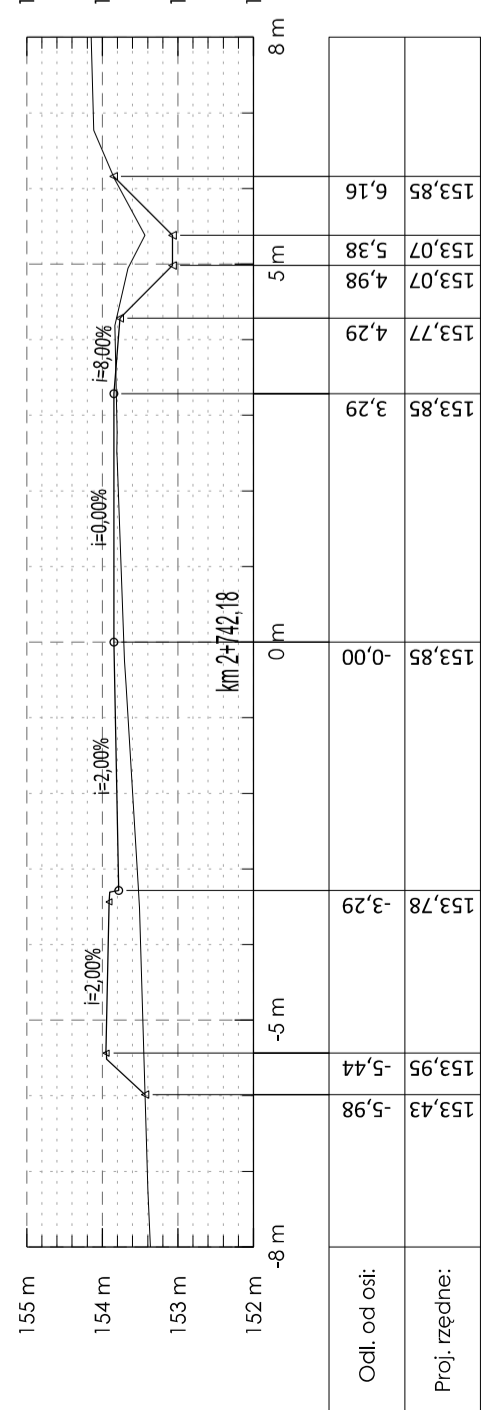
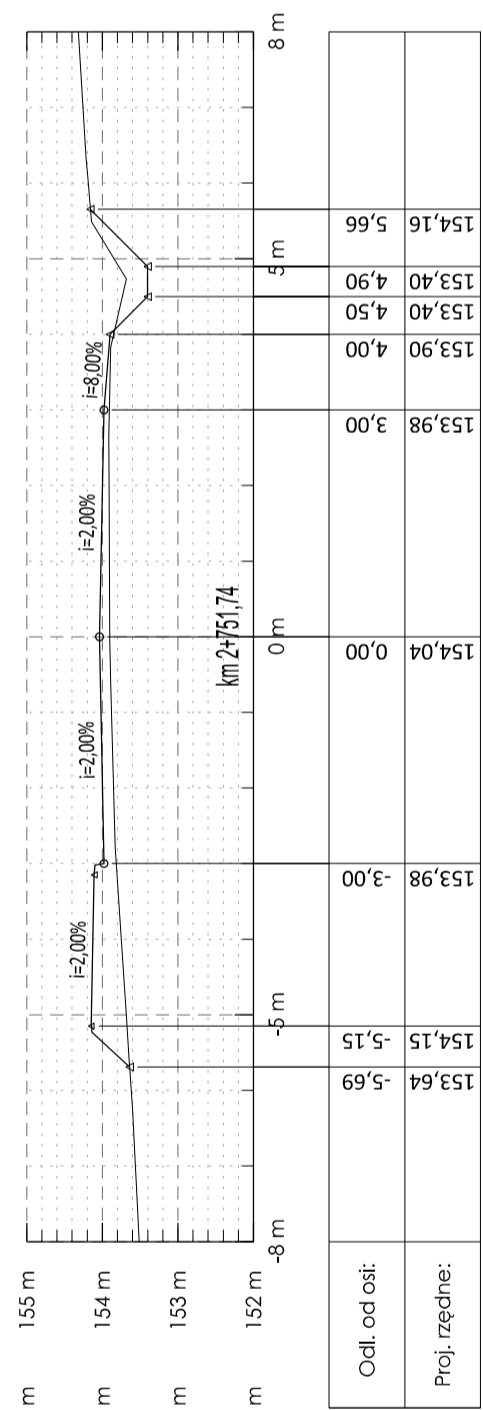
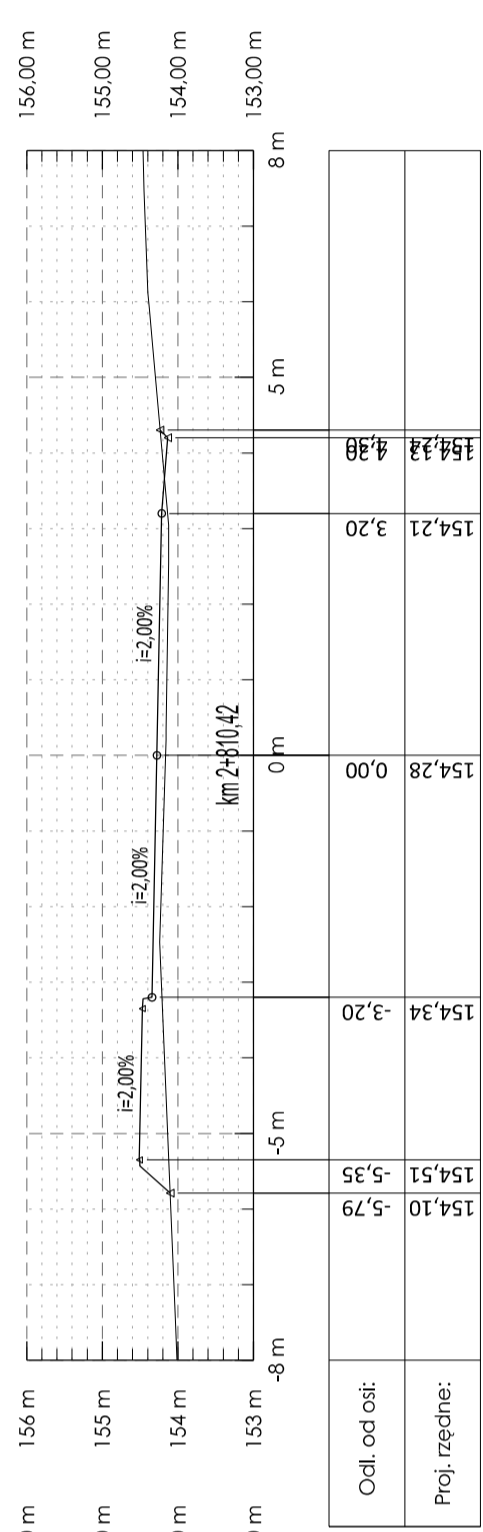

od km 2+725,76 - do km 2+810,42

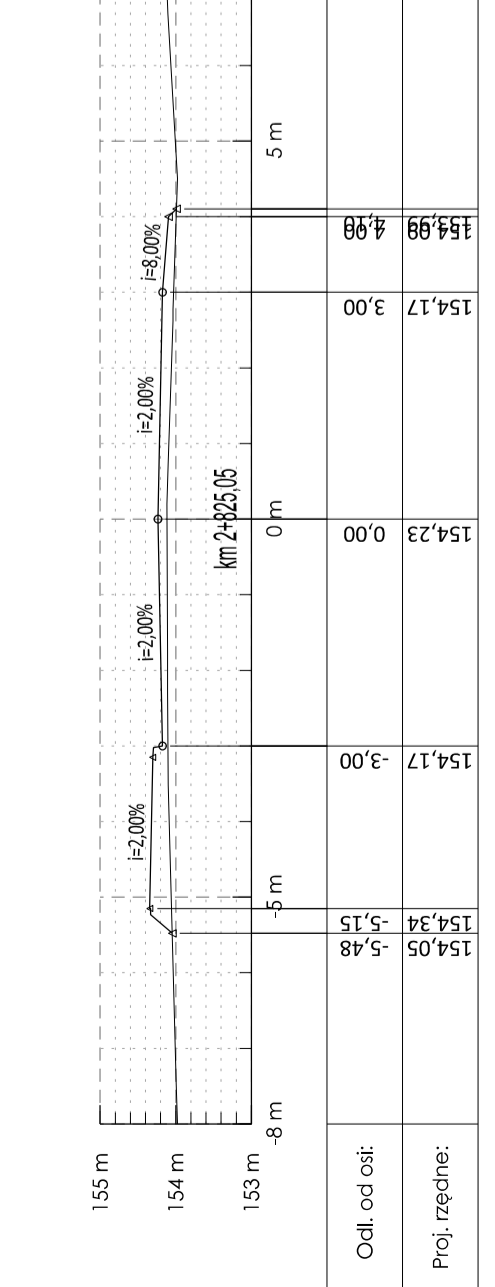
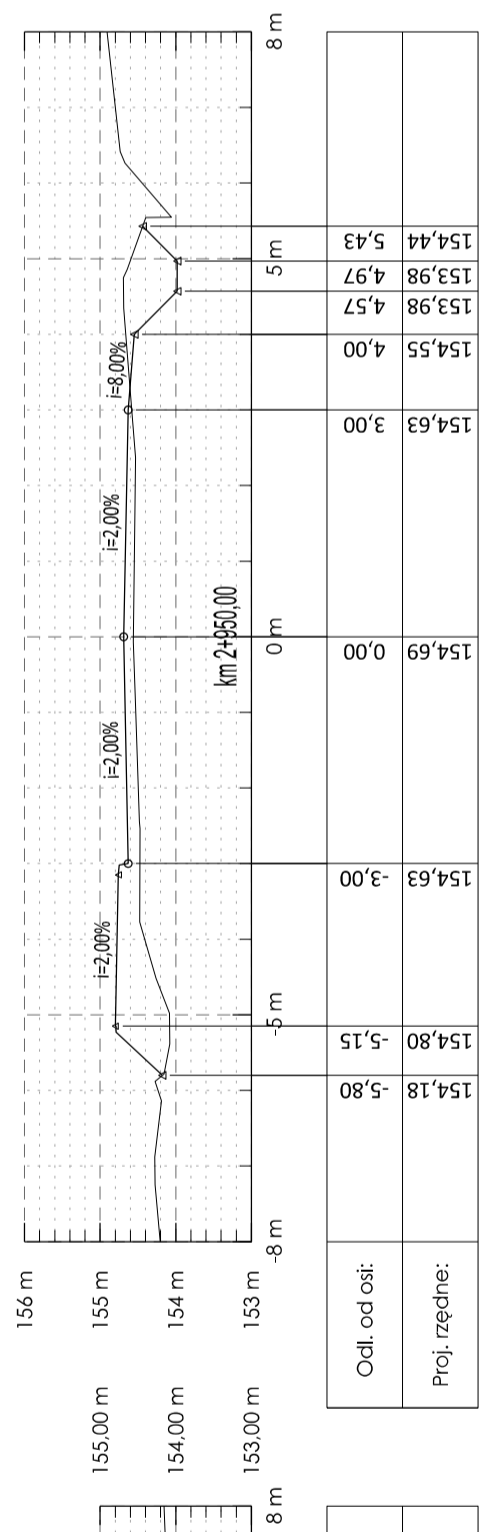
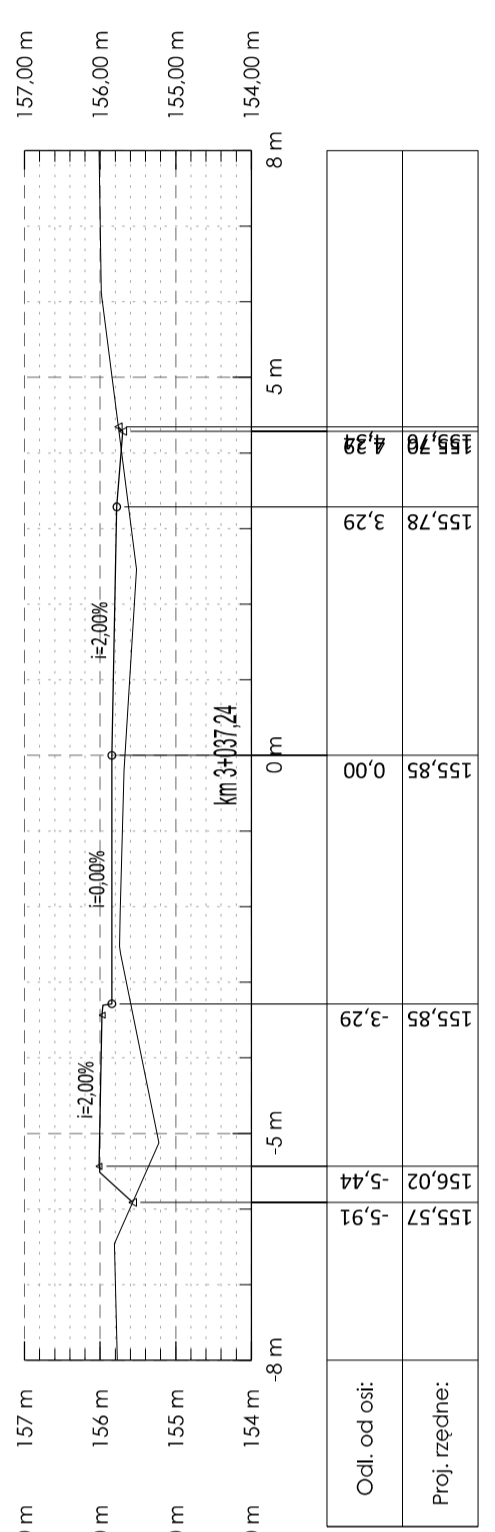
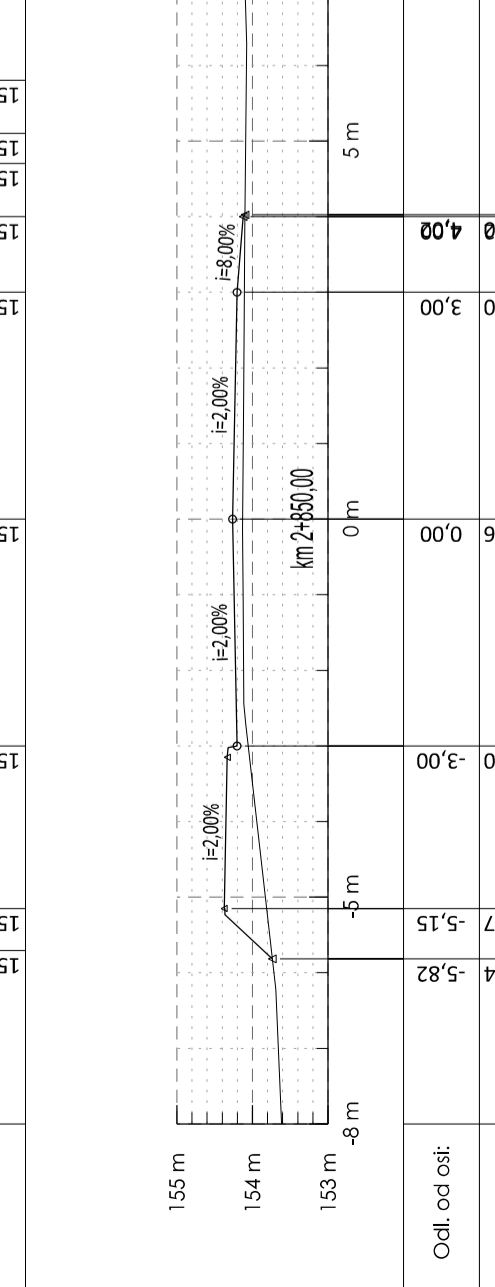
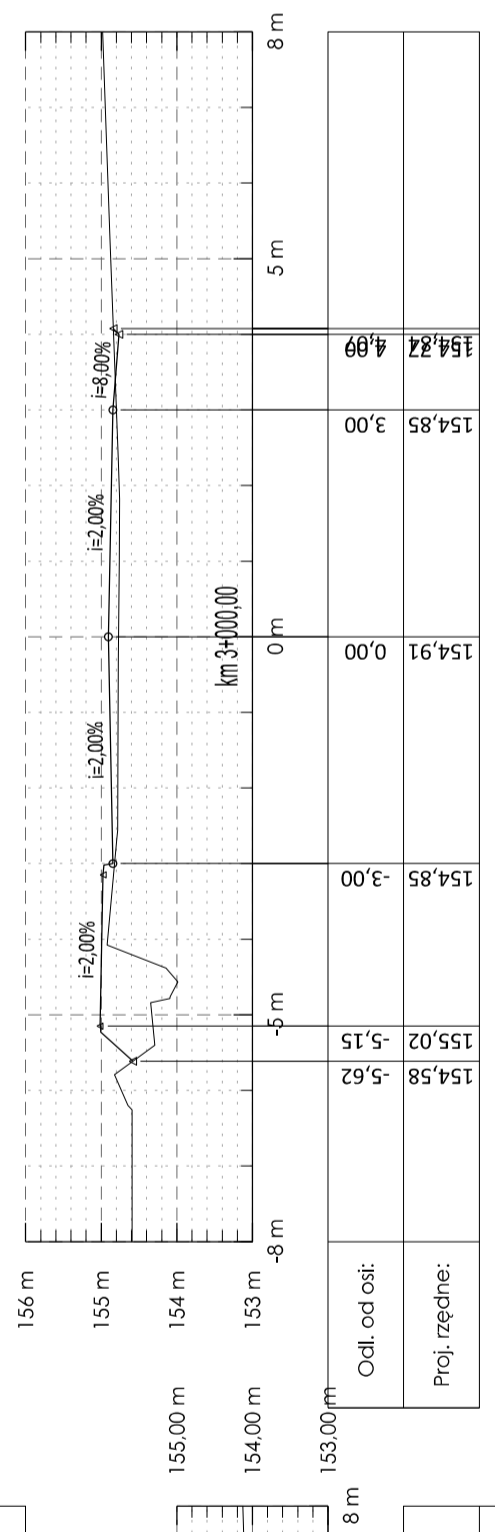
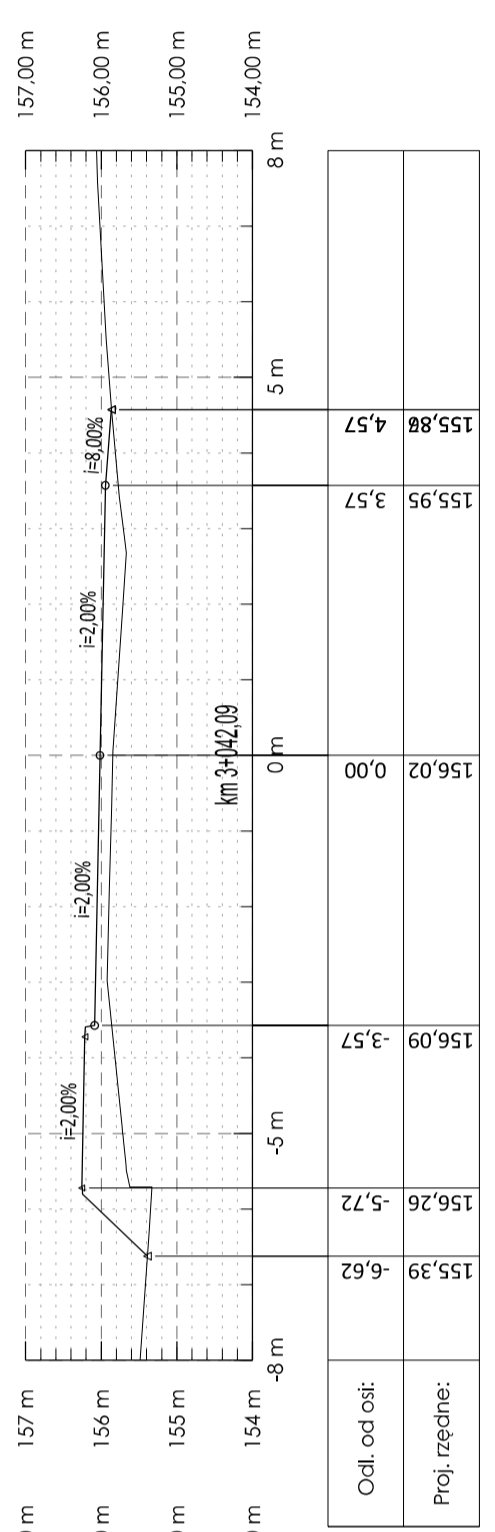
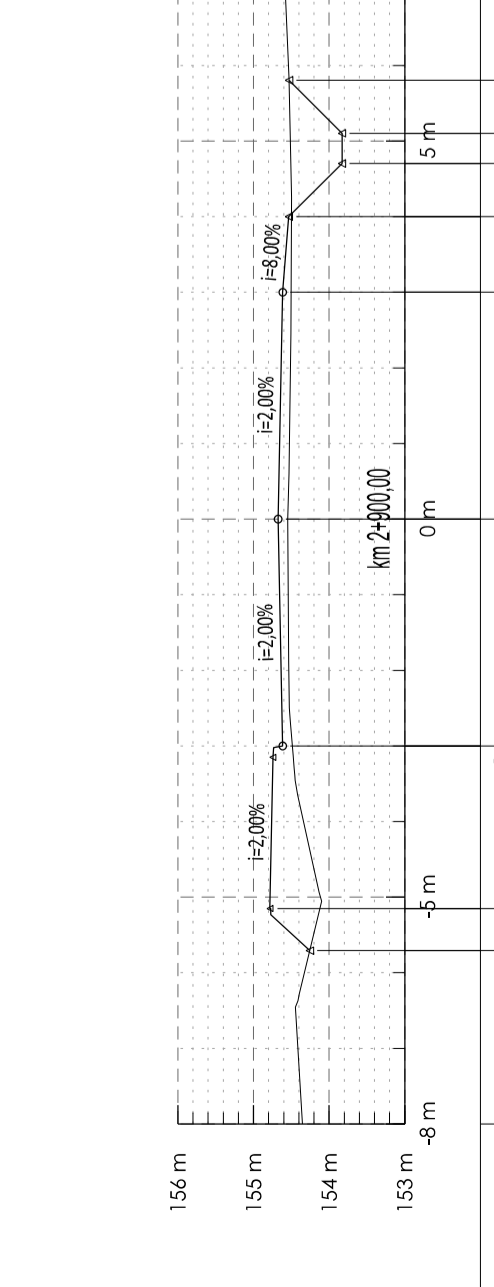
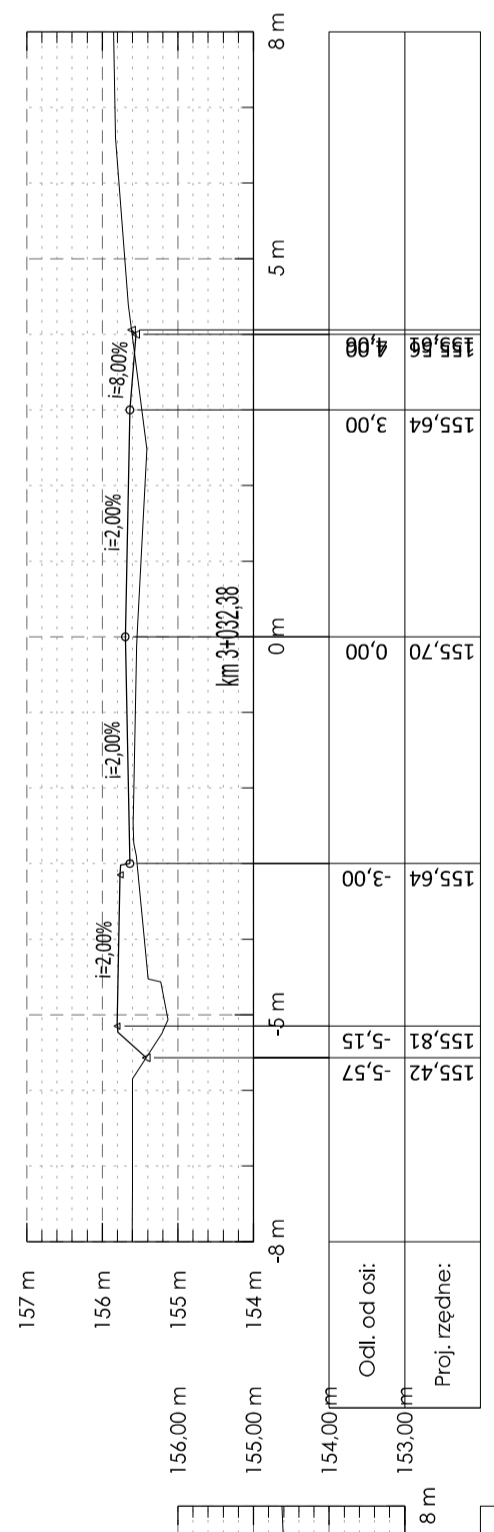
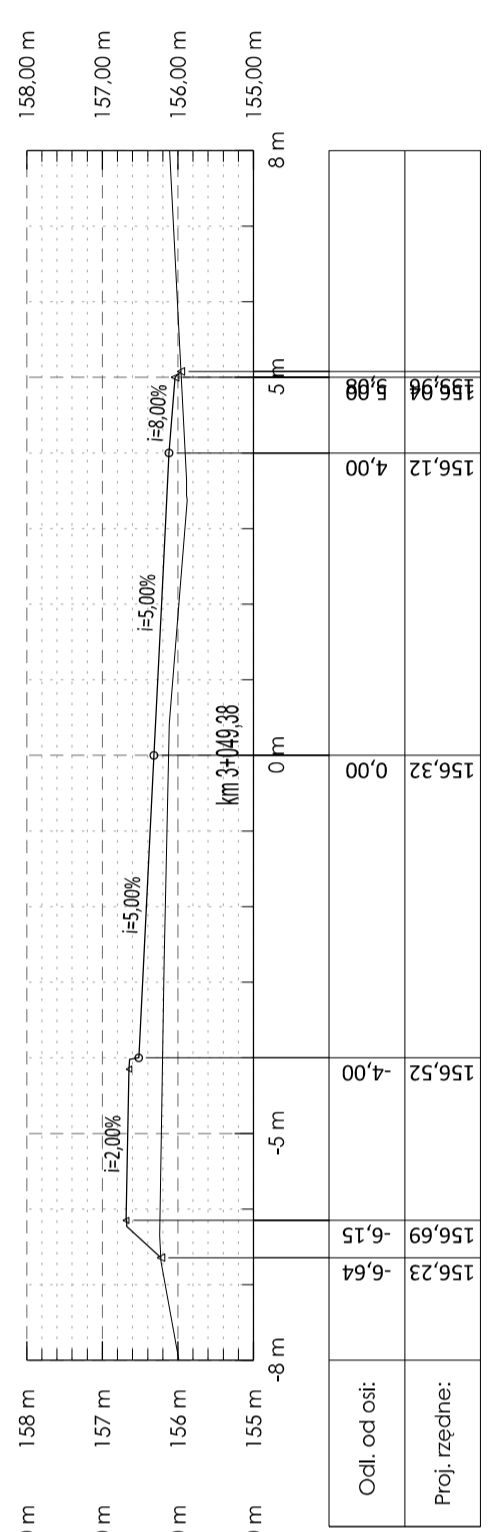

 Starostwo Powiatowe w Grojcu ul. Piłsudskiego 59 05-600 Grojciec	Faza projektu: PROJEKT BUDOWLANO - WYKONAWCZY	
	Wykonawca:	Inwestor:
Projektant: mgr inż. Krzysztof Suliga upr. nr 63/PO5/12	Inżynieria ruchu: mgr inż. Krzysztof Suliga upr. nr 63/PO5/12	Podpis: 
Sprawdzający: mgr inż. Bartłomiej Małekta upr. nr 1042/0405/PO00/10	Skala rysunku: TOM-I 1:50	Podpis: 
Tom:	Data:	VIII.2017
Tytuł rysunku: Przekroje charakterystyczne	Nr rysunku: PC-1602-10	

od km 2+825,05 - do km 3+049,38



 Starostwo Powiatowe w Grójcu ul. Piłsudskiego 59 05-600 Grójec	Faza projektu:	PROJEKT BUDOWLANO - WYKONAWCZY
	Inżynieria ruchu: Projektant: mgr inż. Krzysztof Suliga upr. nr 63/PO/S/12 Podpis: 	Wykonawca: Biuro Projektów Infrastrukturalnych Krzysztof Suliga, ul. Teczowa 3/6, 05-270 Marki tel. 791 95 65 51, email: biuro@bpi-ke.pl
Sprawdzający: mgr inż. Bartłomiej Małecka upr. nr 0405/POOD/10 Podpis: 	Tom: TOM-I Skala rysunku: 1:50	Data: VIII.2017
Tytuł rysunku: Przebiegowa DROG POWIATOWYCH NR 1602W WILCZORUDA - MICHROW I 1601W PNIEWY - REMBERTÓW		Nr rysunku: PC-1602-11

od km 3+050,00 - do km 3+250,00

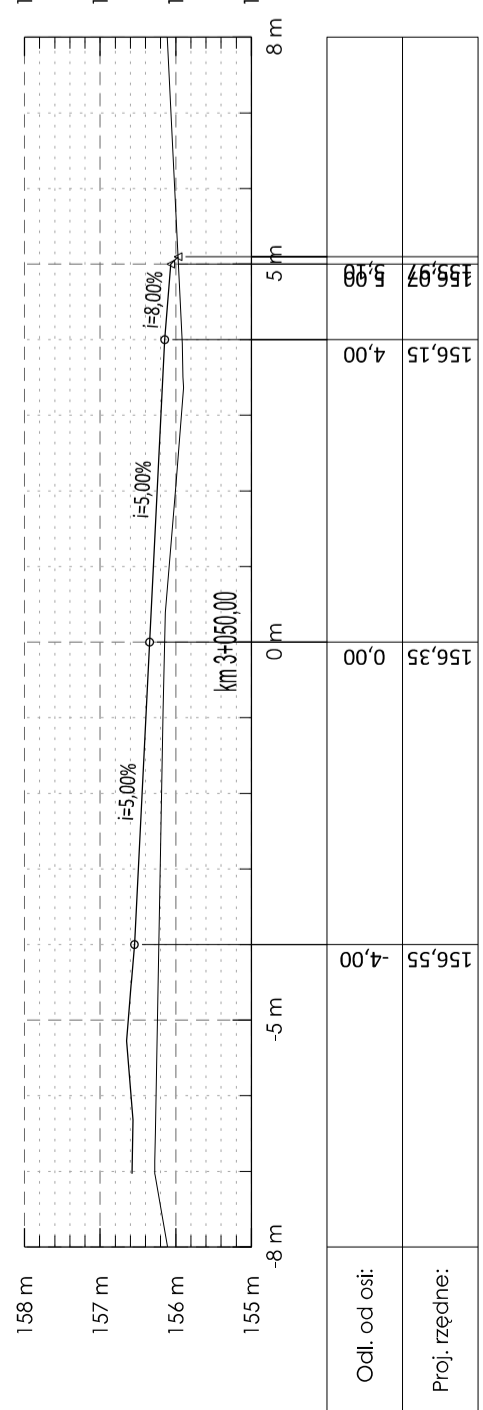
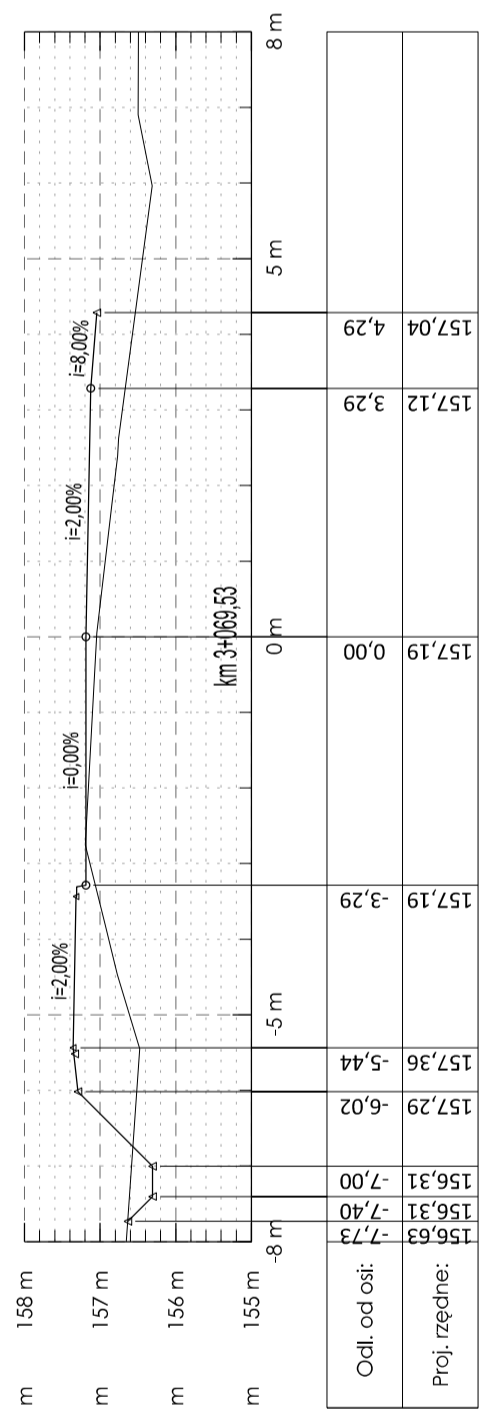
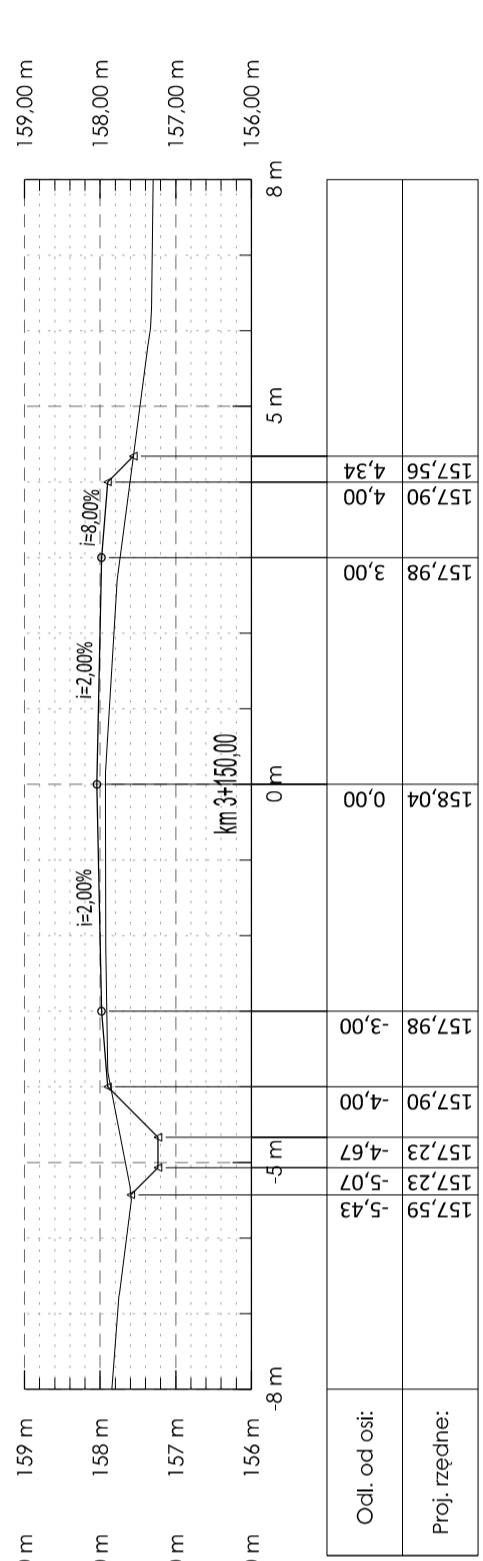
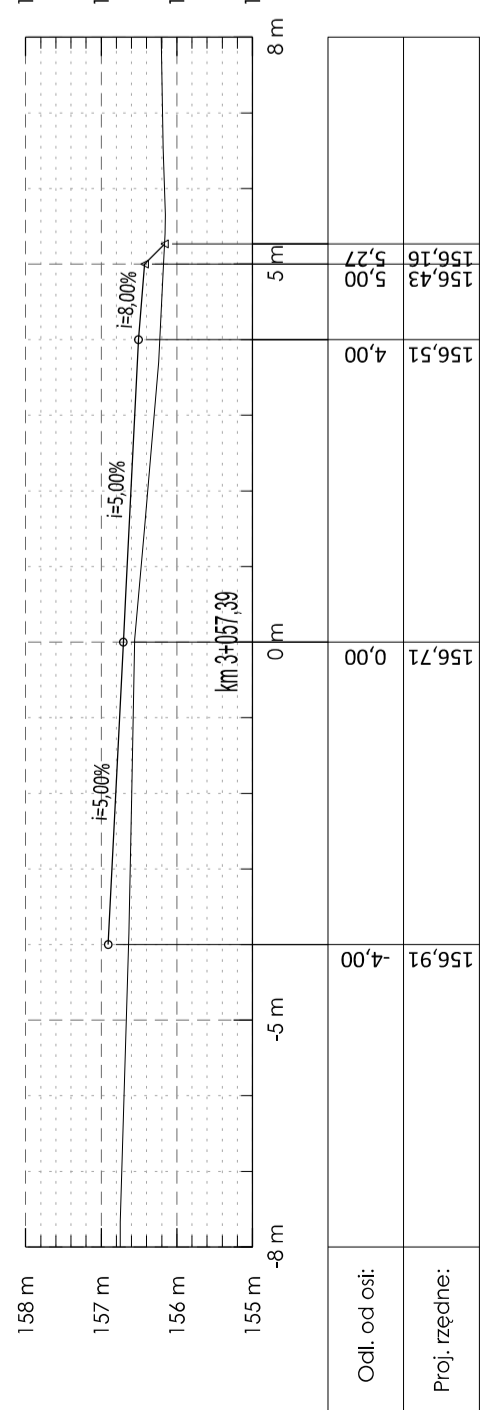
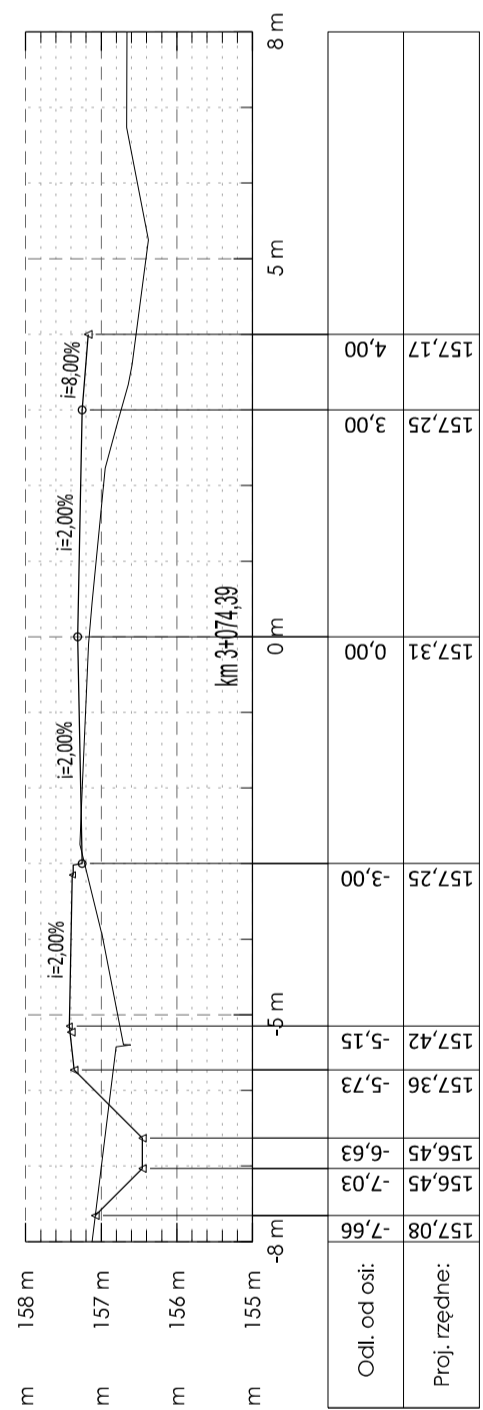
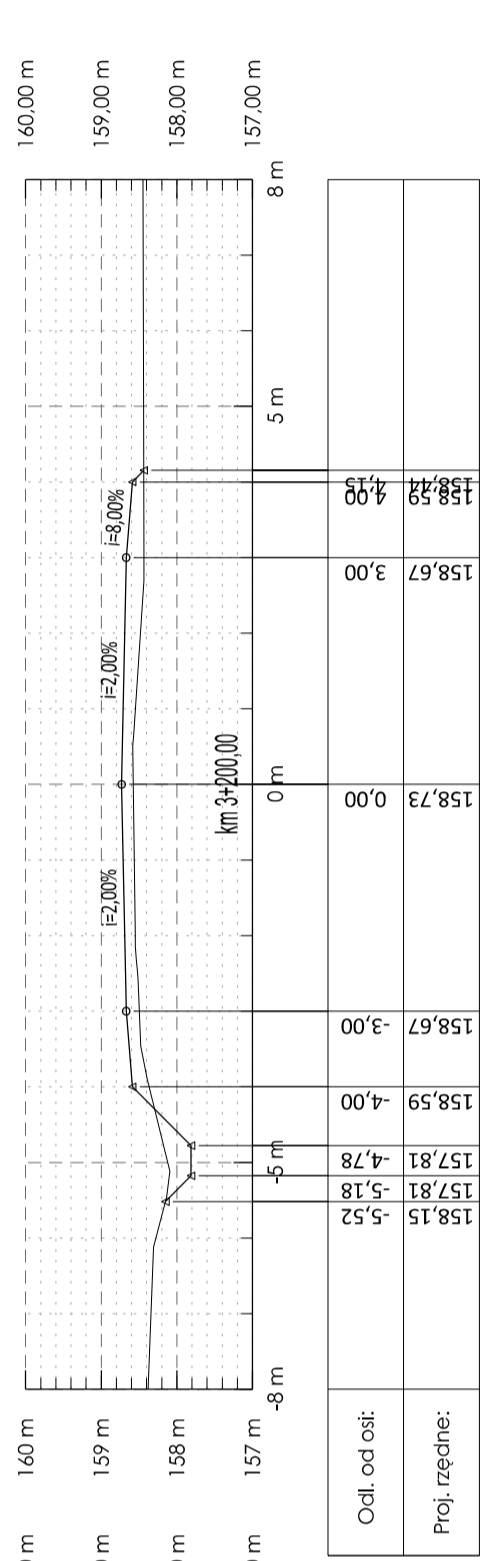
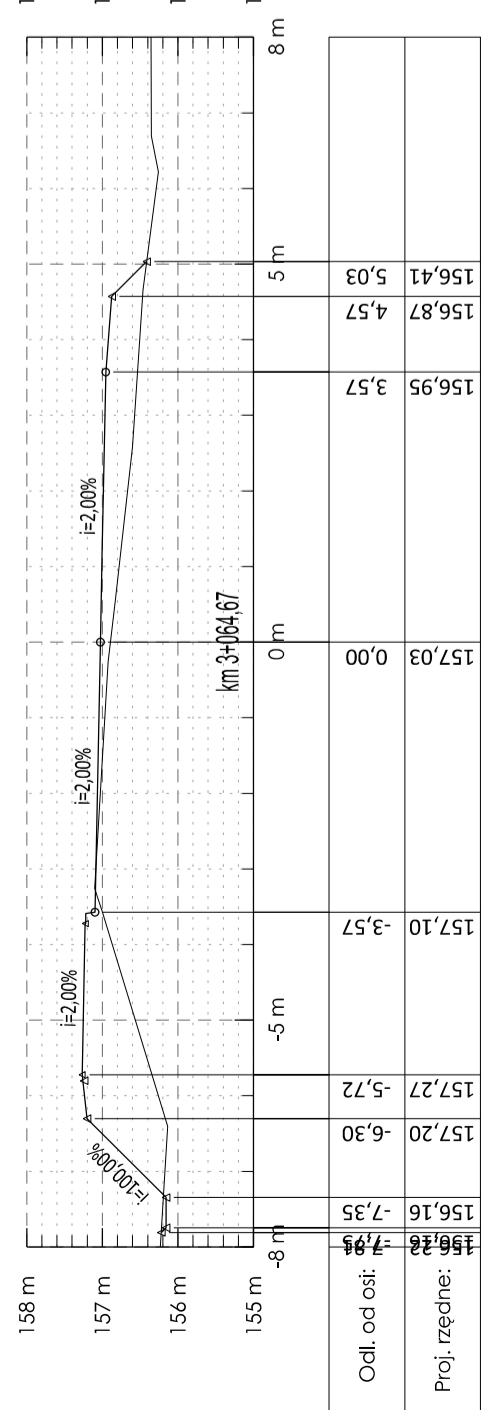
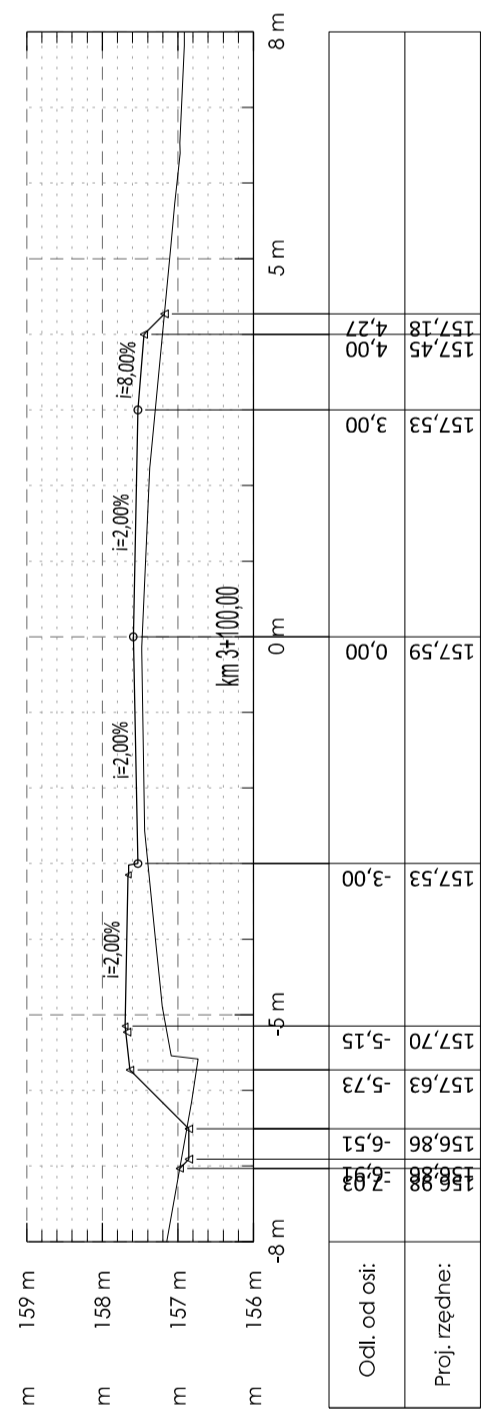
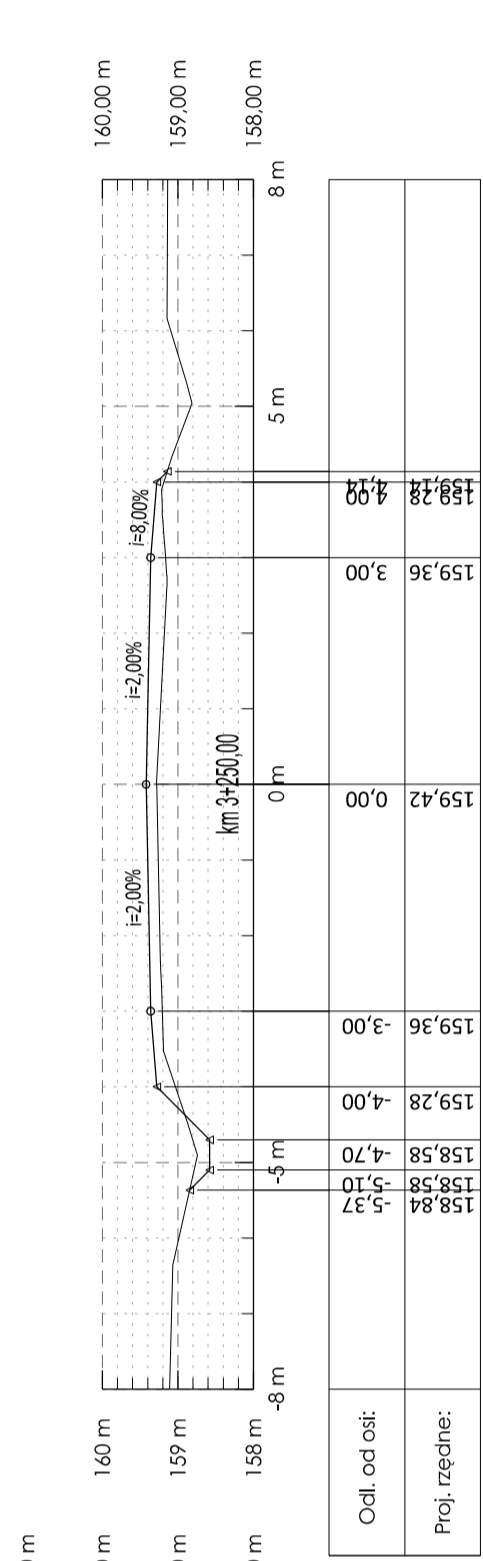

INWESTOR: Starostwo Powiatowe w Grojcu
ul. Piłsudskiego 59
05-600 Grojce

WYKONAWCA: BPI
Biurowy Projektów Infrastrukturalnych
Krzysztof Suliga, ul. Teczowa 3/6, 05-270 Marki
tel. 791 95 65 51, email: biuro@bpi-ko.pl

Faza projektu: PROJEKT BUDOWLANO - WYKONAWCZY

Projektant: mgr inż. Krzysztof Suliga
upr. nr 83/PO/S/12

Sprawdzający: mgr inż. Bartłomiej Małętka
upr. nr IMZ/0405/POD/10

Podpis: [Signature]

Podpis: [Signature]

Tom: TOM-I

Skala rysunku: 1:50

Data: VIII.2017

Typul rysunku: Przekroje charakterystyczne

Nr rysunku: PC-1602-12

od km 3+300,00 - do km 3+700,00

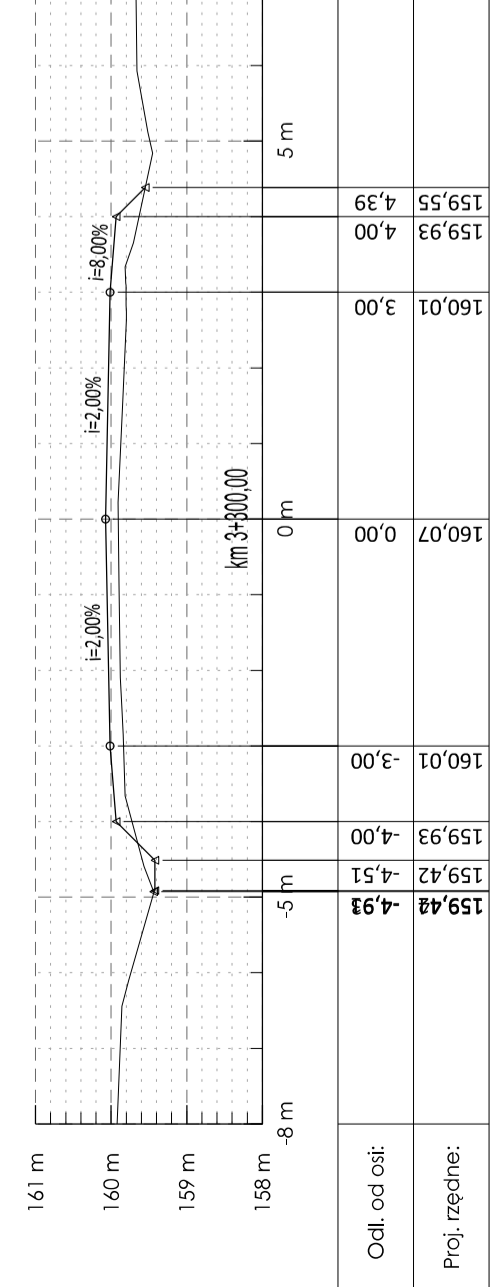
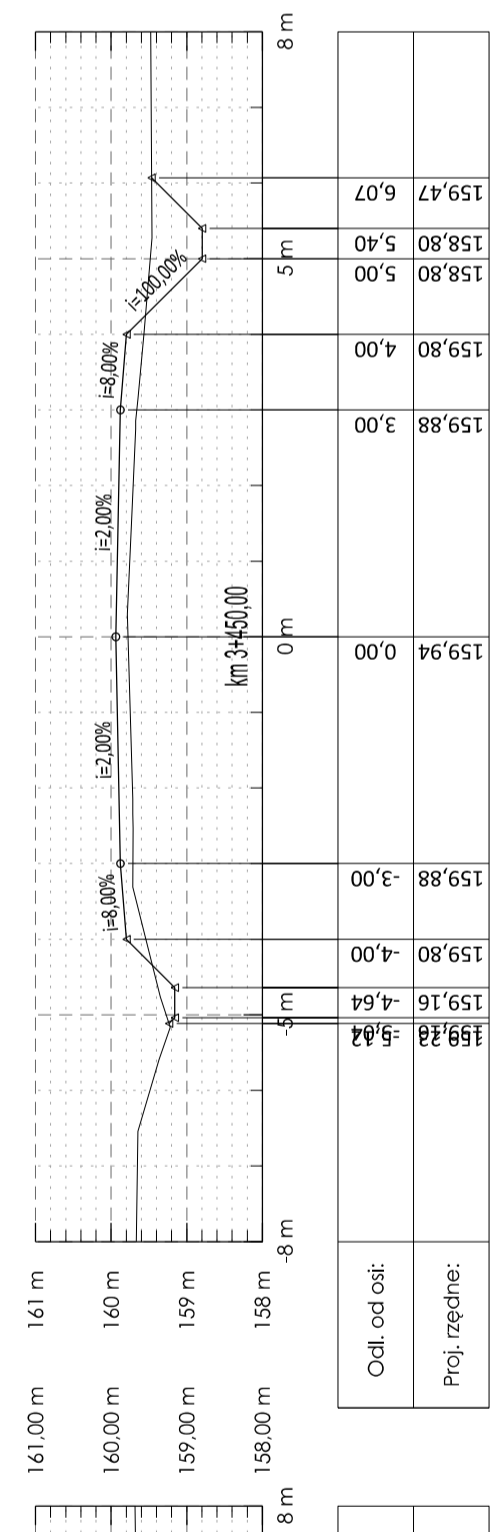
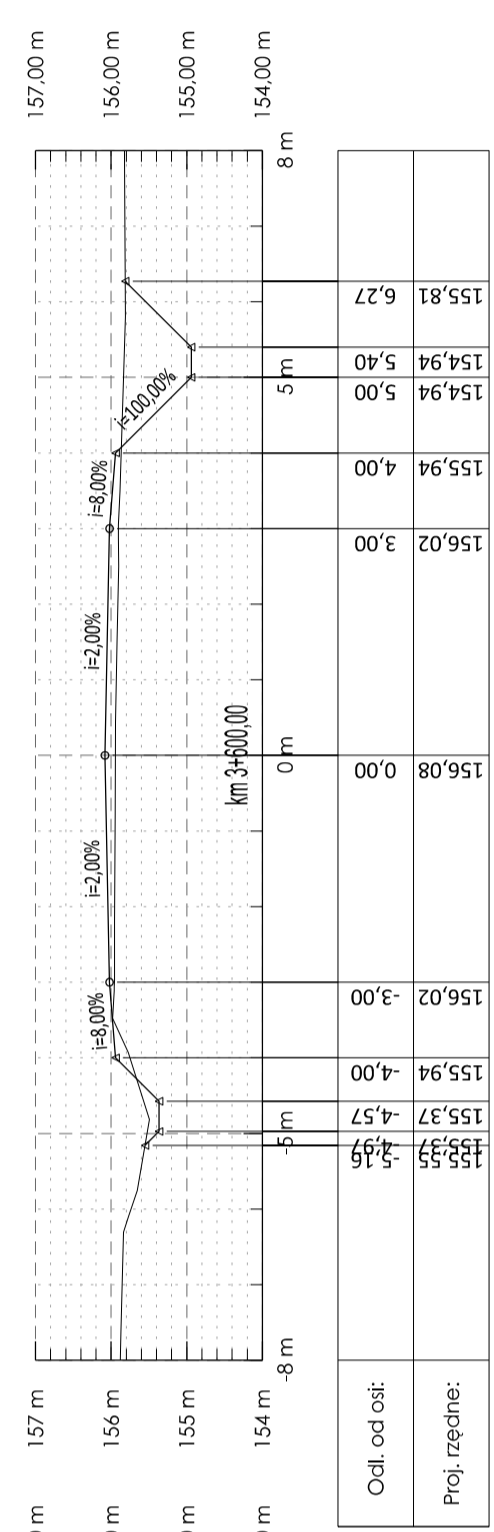
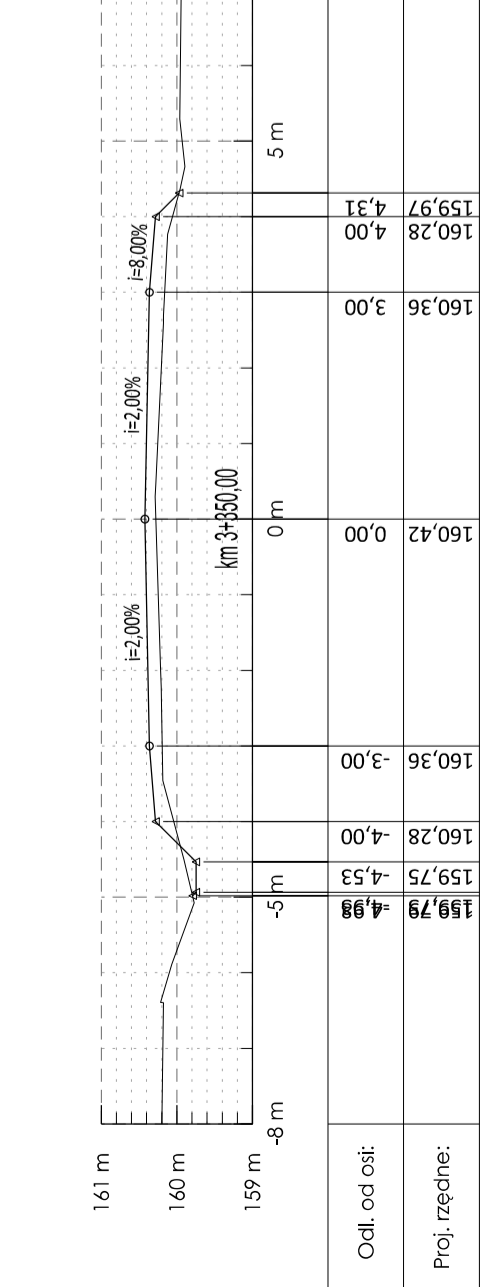
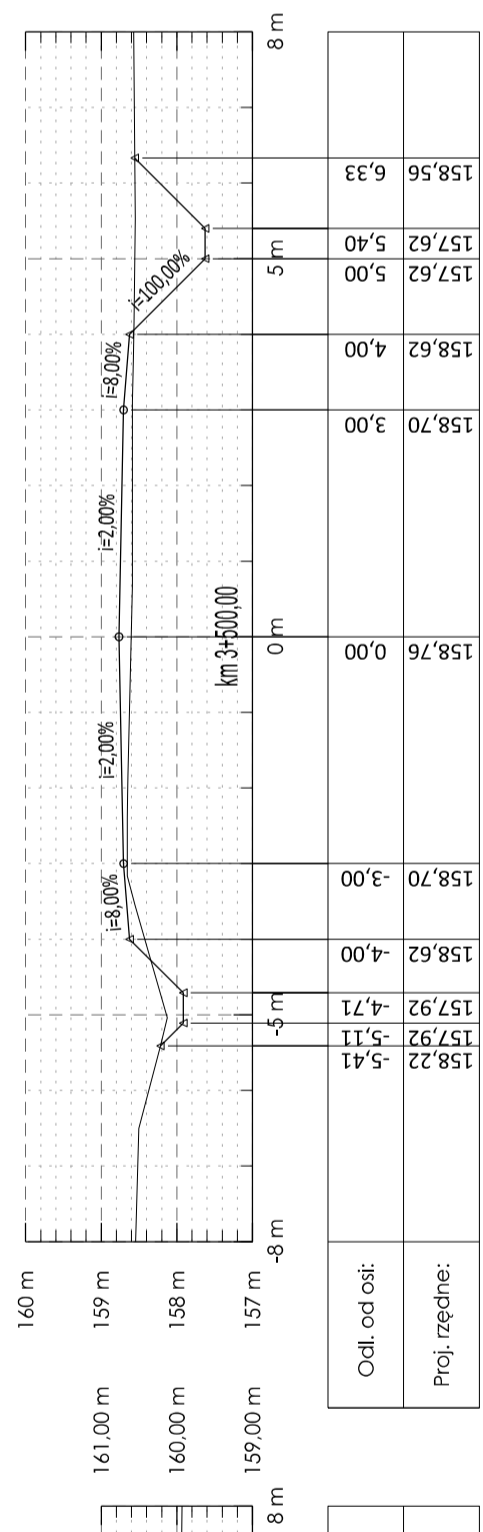
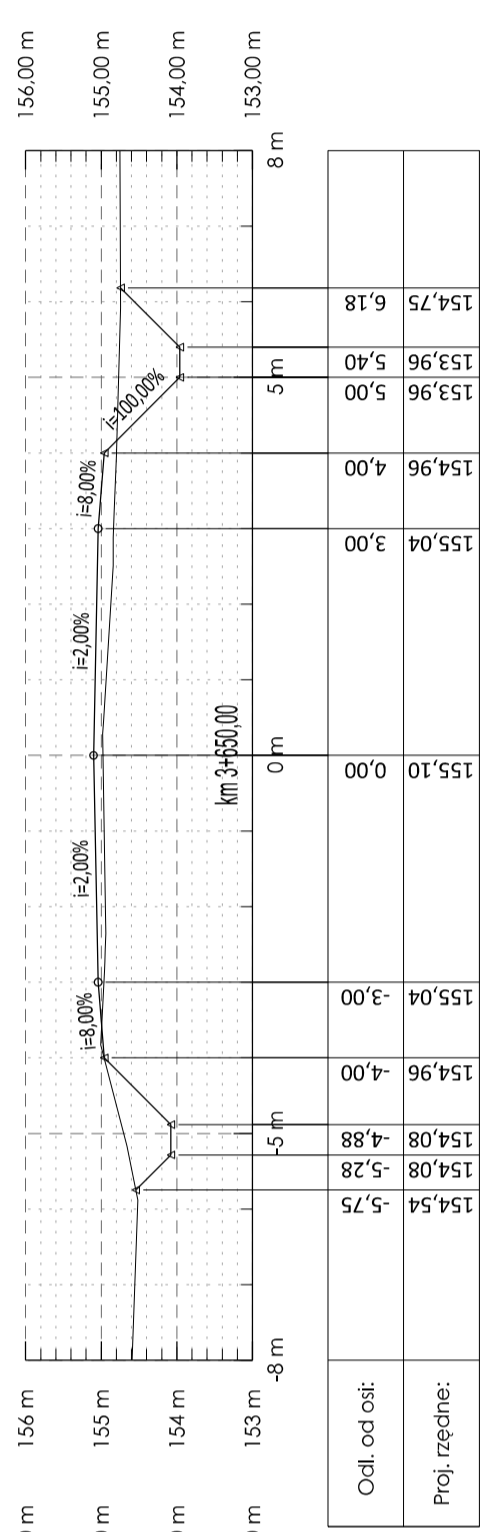
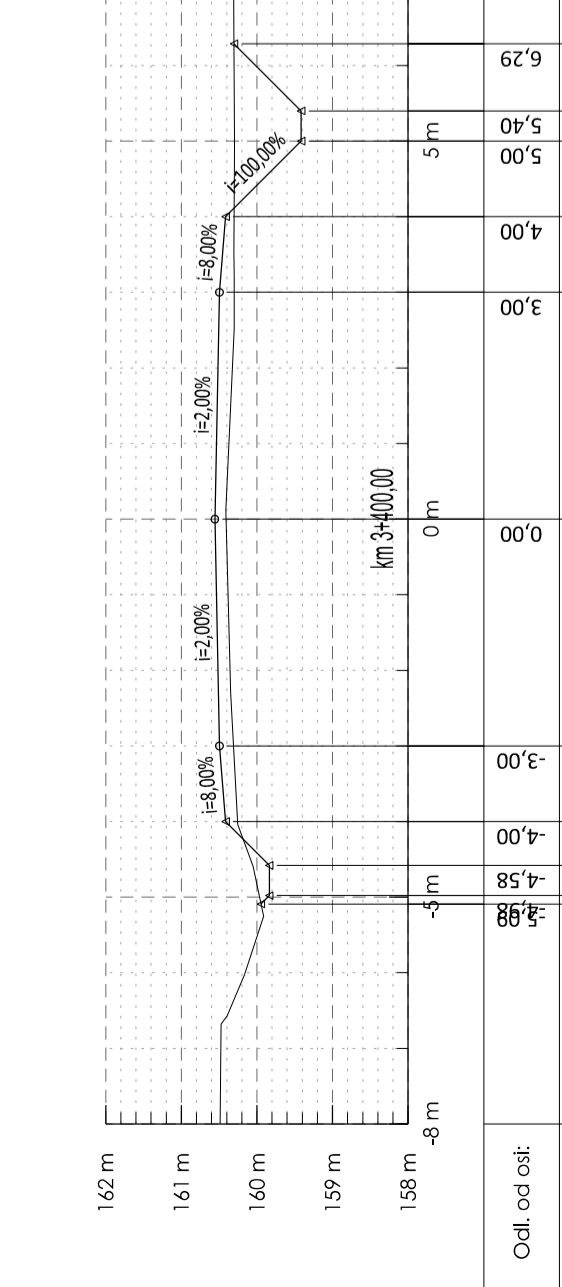
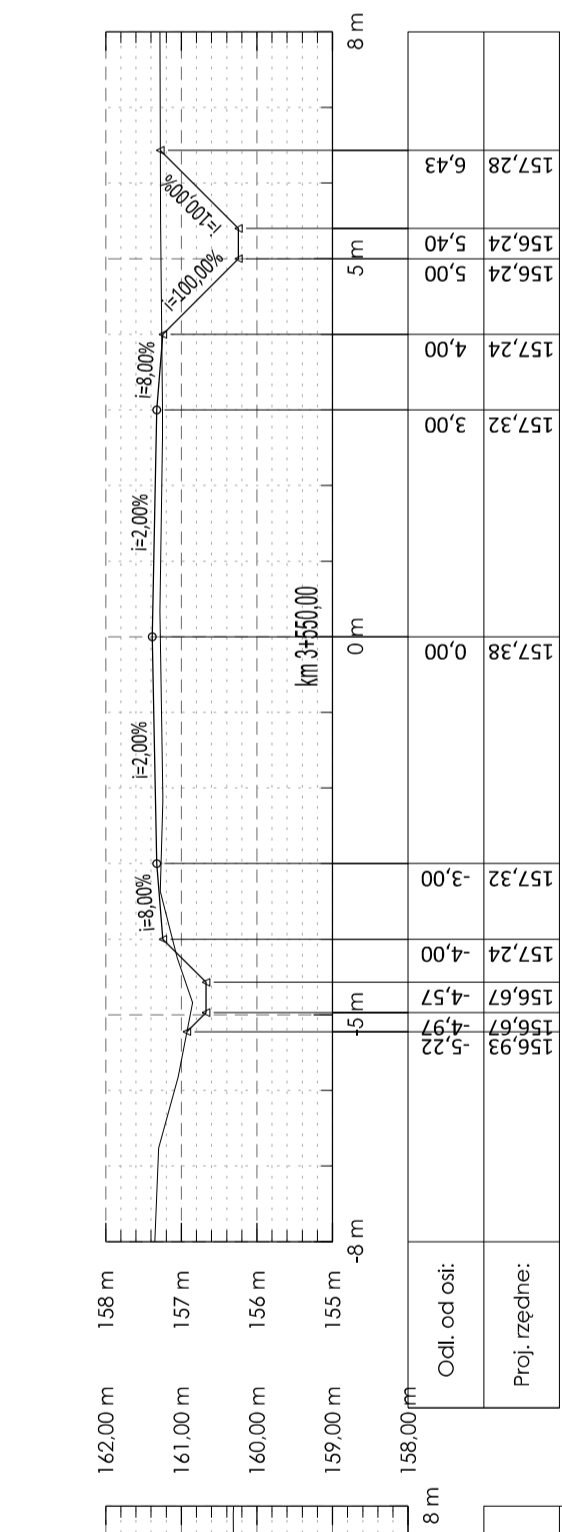
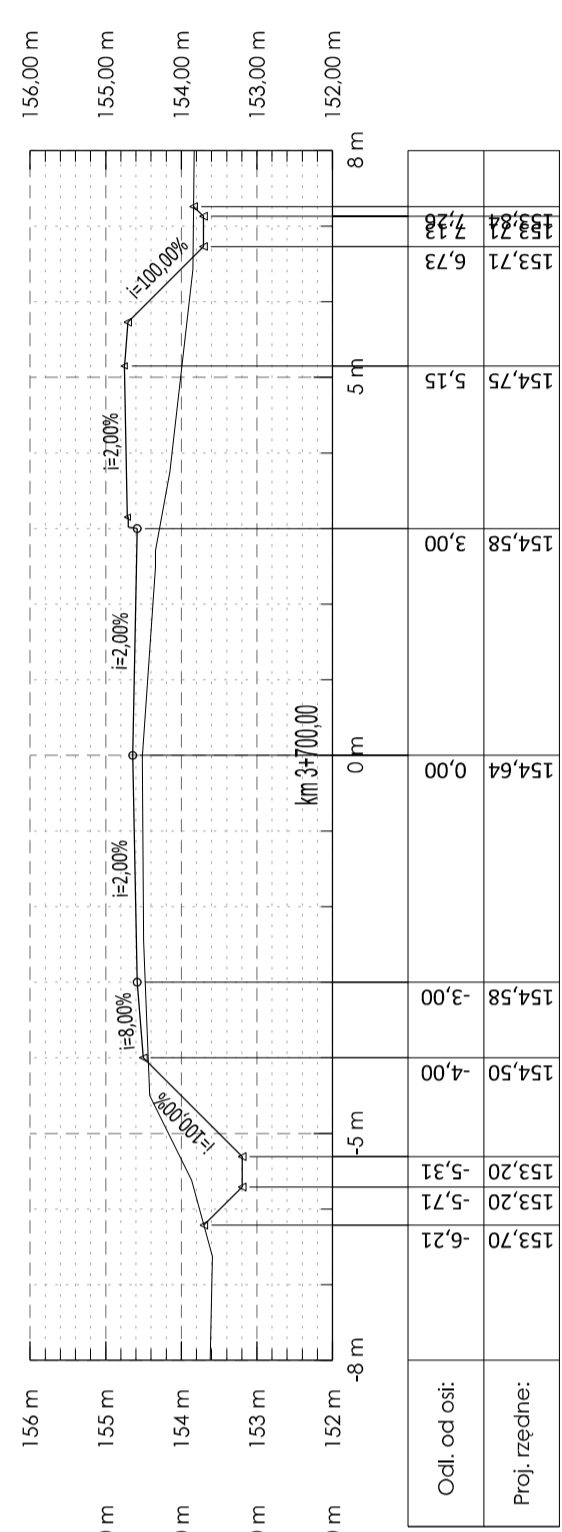

INWESTOR: Starostwo Powiatowe w Grojcu
ul. Piłsudskiego 59
05-600 Grojec

WYKONAWCA: BPI
Biurowisko: PRZEBUDOWA DRÓG POWIATOWYCH NR 1602W WILCZORUDA - MICHROW I 1601W PNIEWY - REMBERTÓW

Faza projektu: PROJEKT BUDOWLANO - WYKONAWCZY

Inżynieria ruchu: mgr inż. Krzysztof Suliga
upr. nr 63/PDS/12

Sprawdzający: mgr inż. Bartłomiej Małętka
upr. nr MAZ/0405/POD/10

Podpis: [Signature]

Podpis: [Signature]

Tom: TOM-I

Skala rysunku: 1:50

Data: VIII.2017

Nr rysunku: PC-1602-13

Przebieg charakterystyczny

od km 3+750,00 - do km 4+150,00

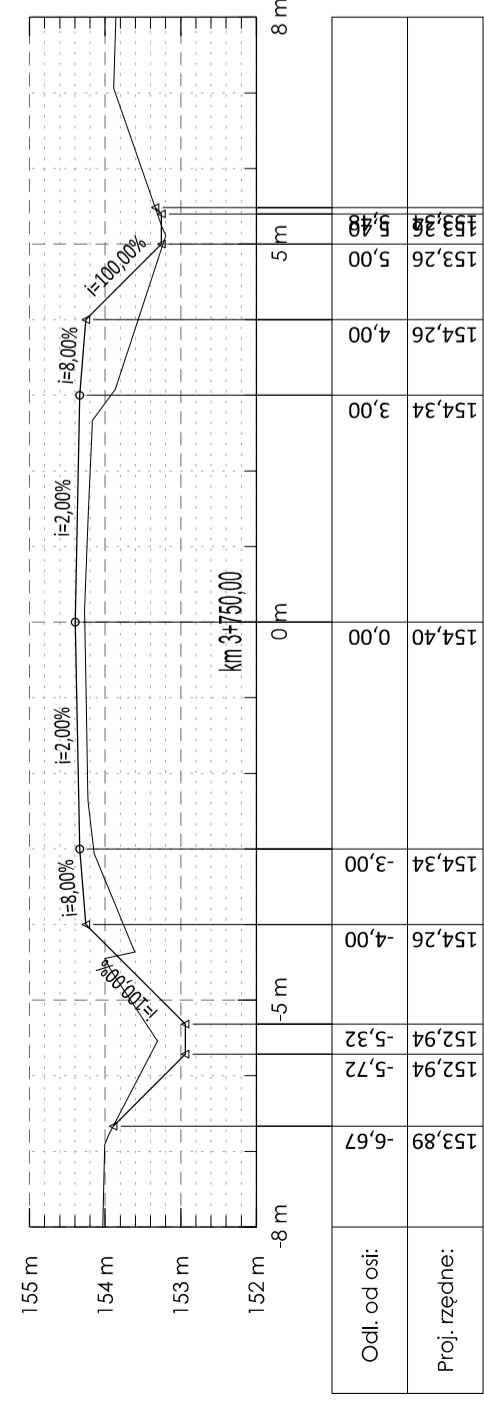
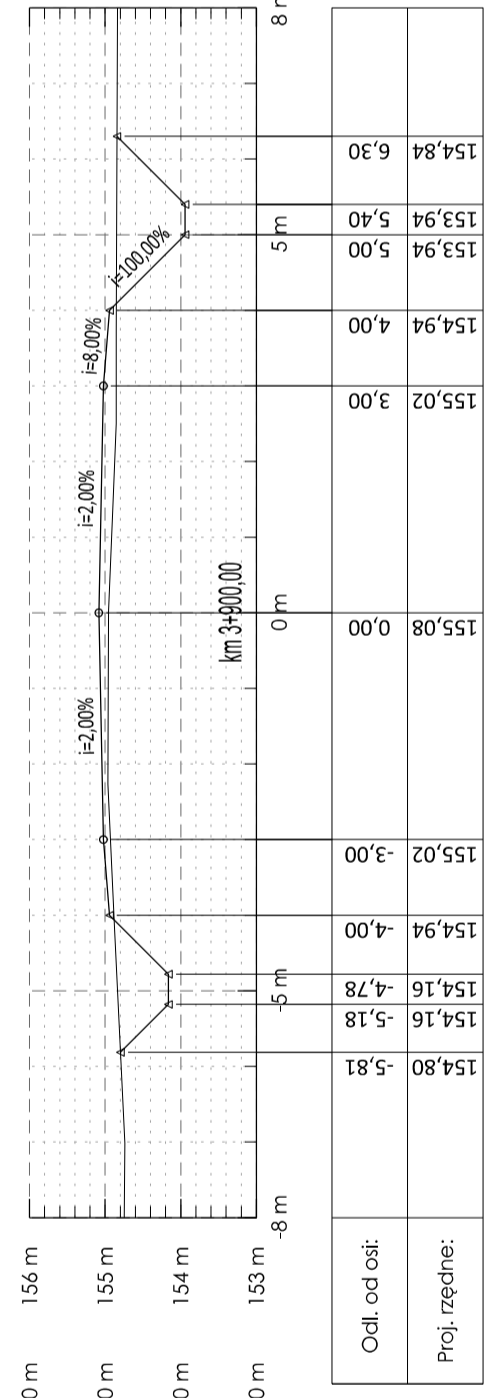
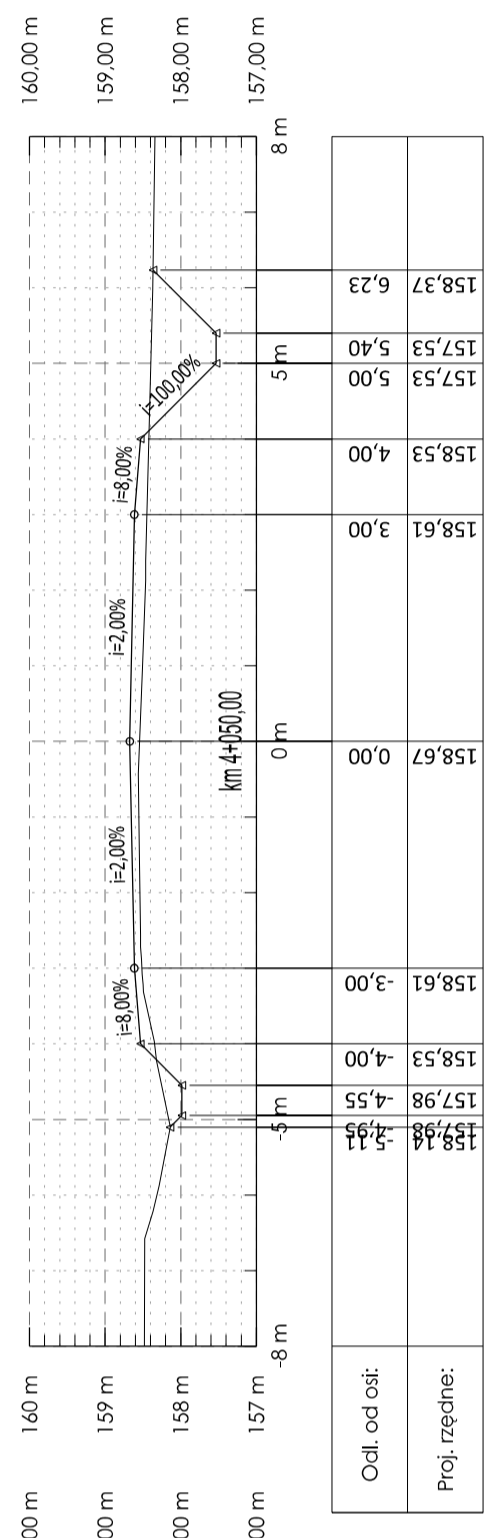
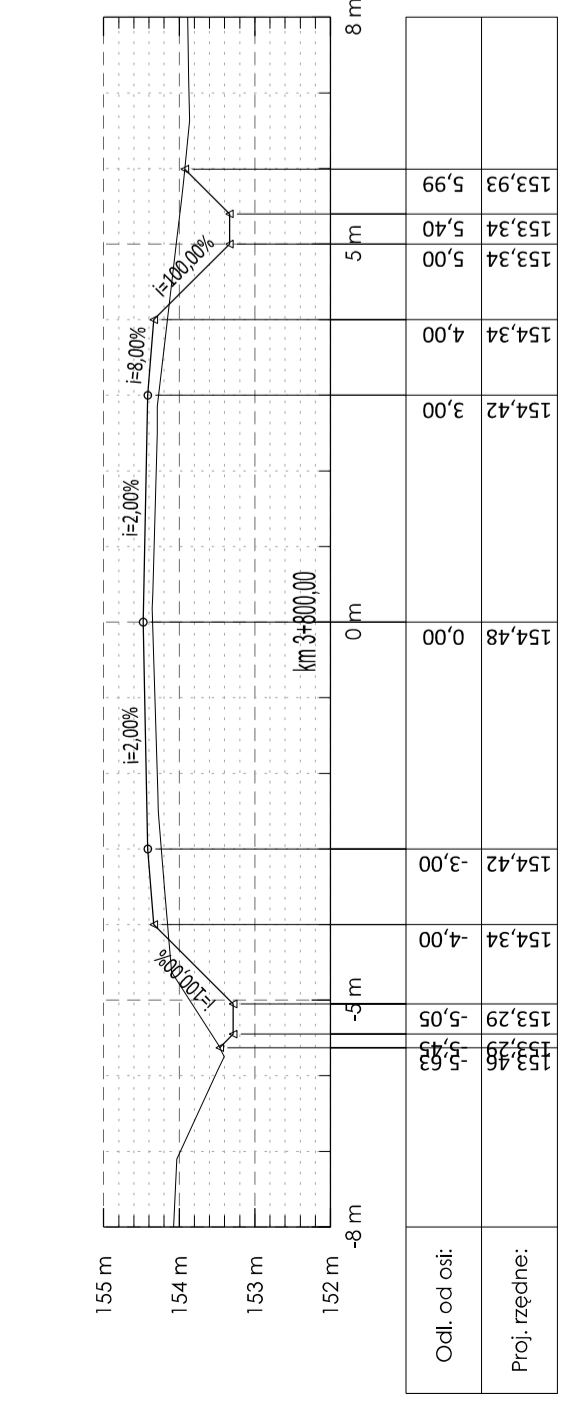
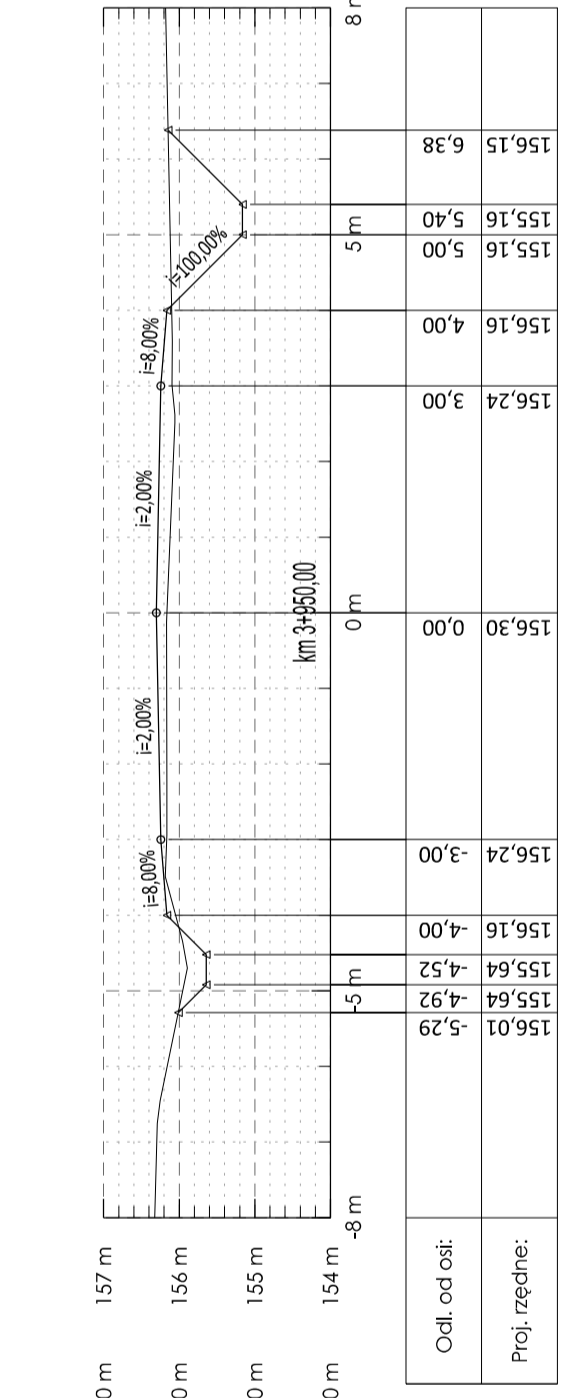
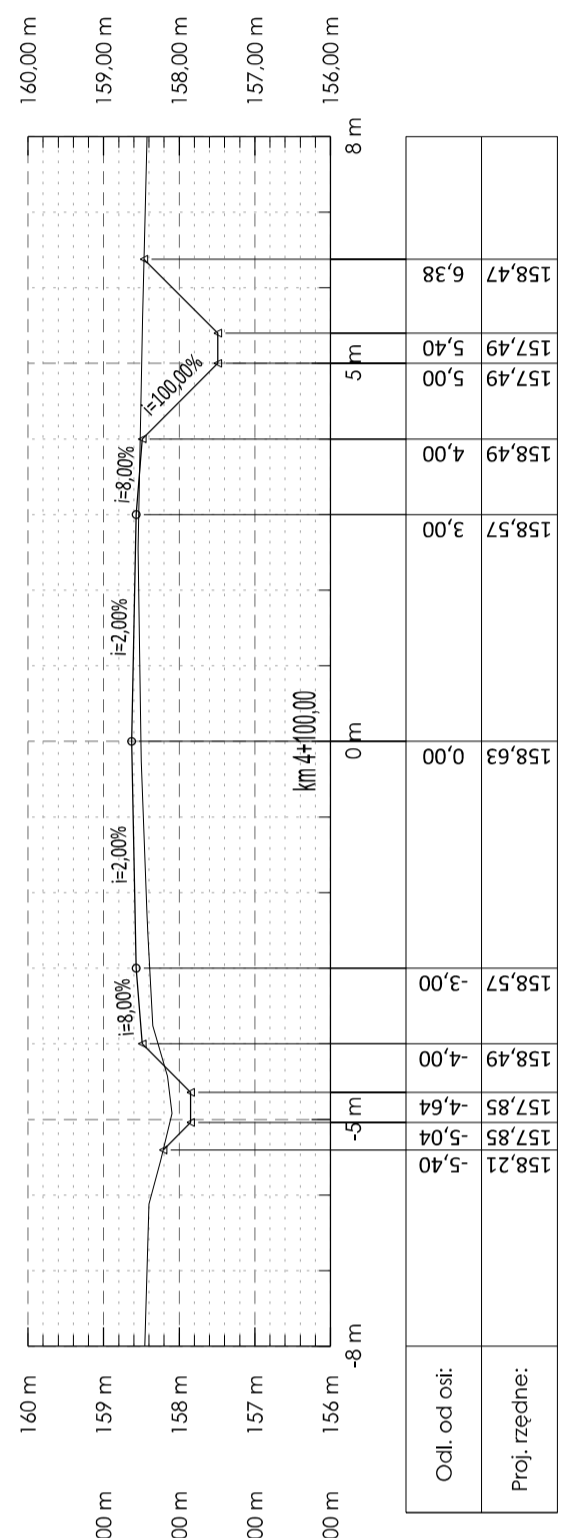
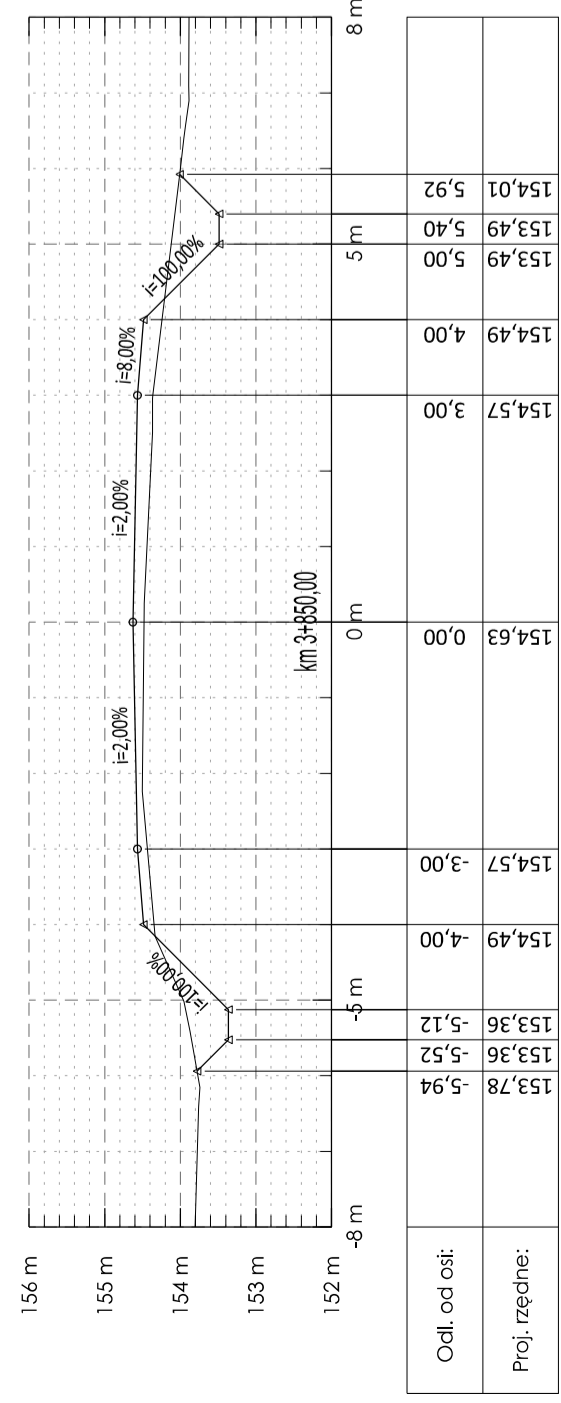
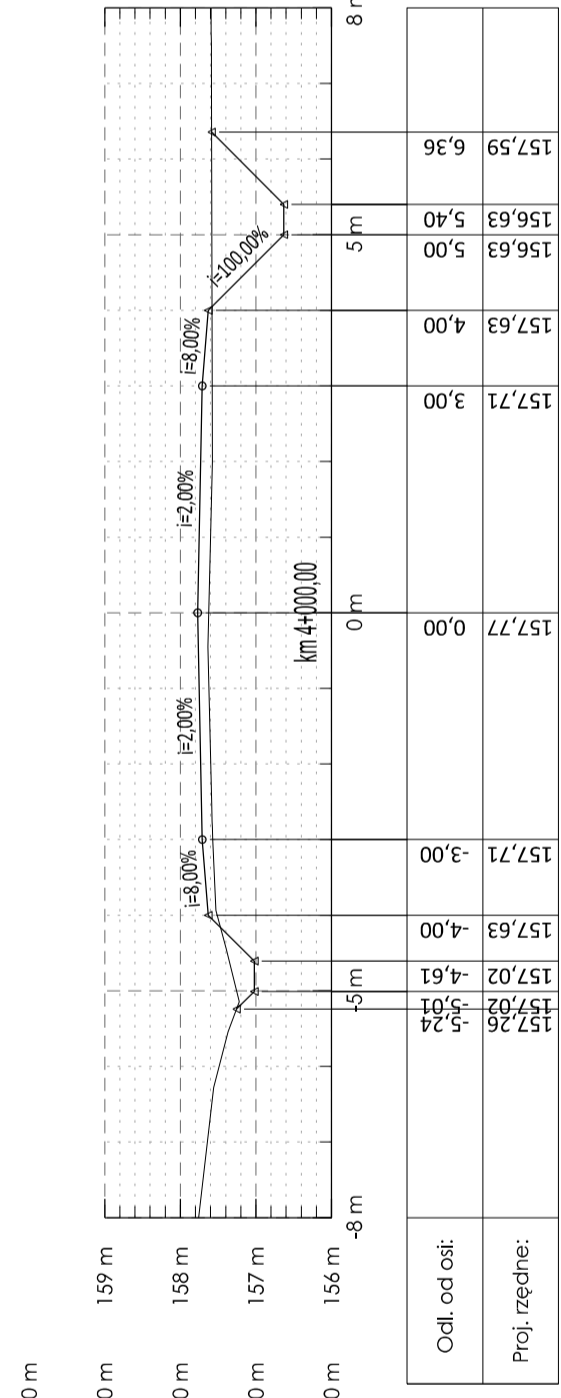
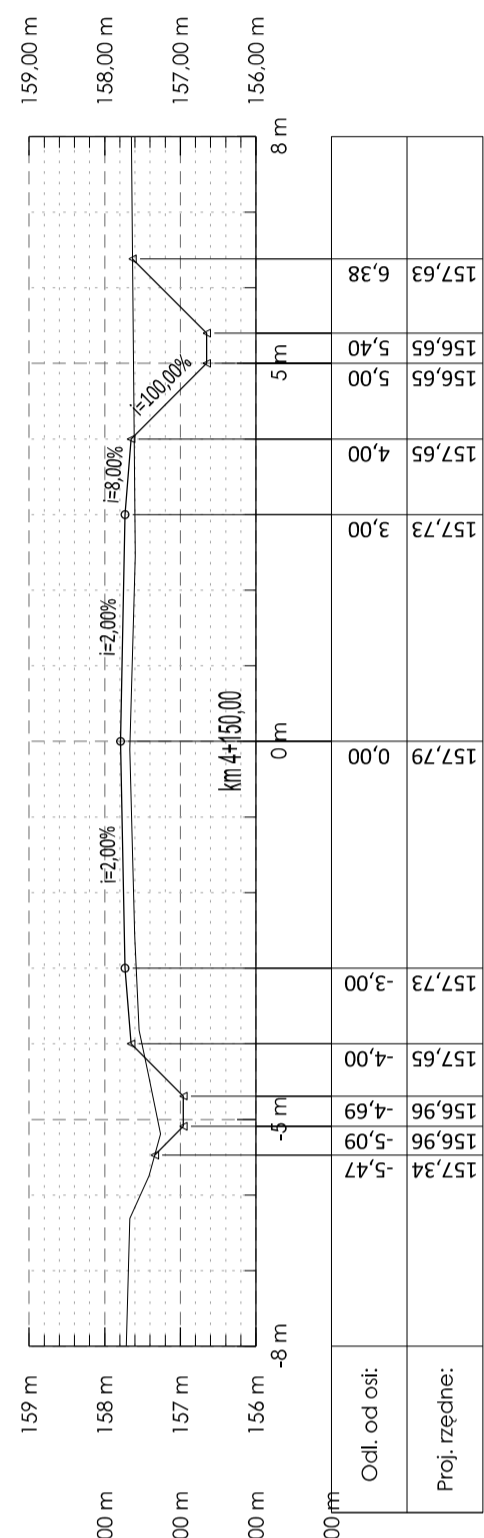

Wykonawca:	Starostwo Powiatowe w Grojcu ul. Piłsudskiego 59 05-600 Grojec	Faza projektu:	PROJEKT BUDOWLANO - WYKONAWCZY
Projektant:	mgr inż. Krzysztof Suliga upr. nr 83/PDS/12	Wykonawca:	Biuro Projektów Infrastrukturalnych Krzysztof Suliga, ul. Teczowa 3/6, 05-270 Marki tel. 791 95 65 51, email: biuro@bpi-ki.pl
Sprawdzający:	mgr inż. Bartłomiej Małecka upr. nr MIAZ/0405/POD/10	Podpis:	
Tom:	Skala rysunku: 1:50	Podpis:	
Tytuł rysunku:	TOM-I	Data:	VIII.2017
Nr rysunku:		Przebieg:	PRZEBUDOWA DRÓG POWIATOWYCH NR 1602W WILCZORUDA - MICHROW I 1601W PNIEWY - REMBERTÓW
		Przebieg charakterystyczny:	PC-1602-14

od km 4+200,00 - do km 4+600,00

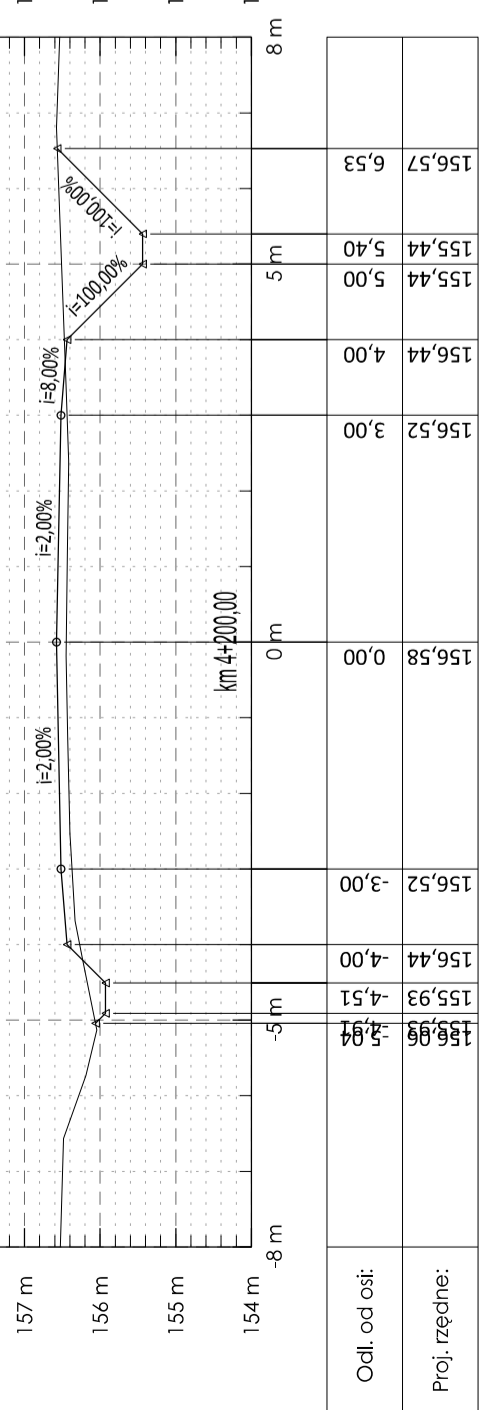
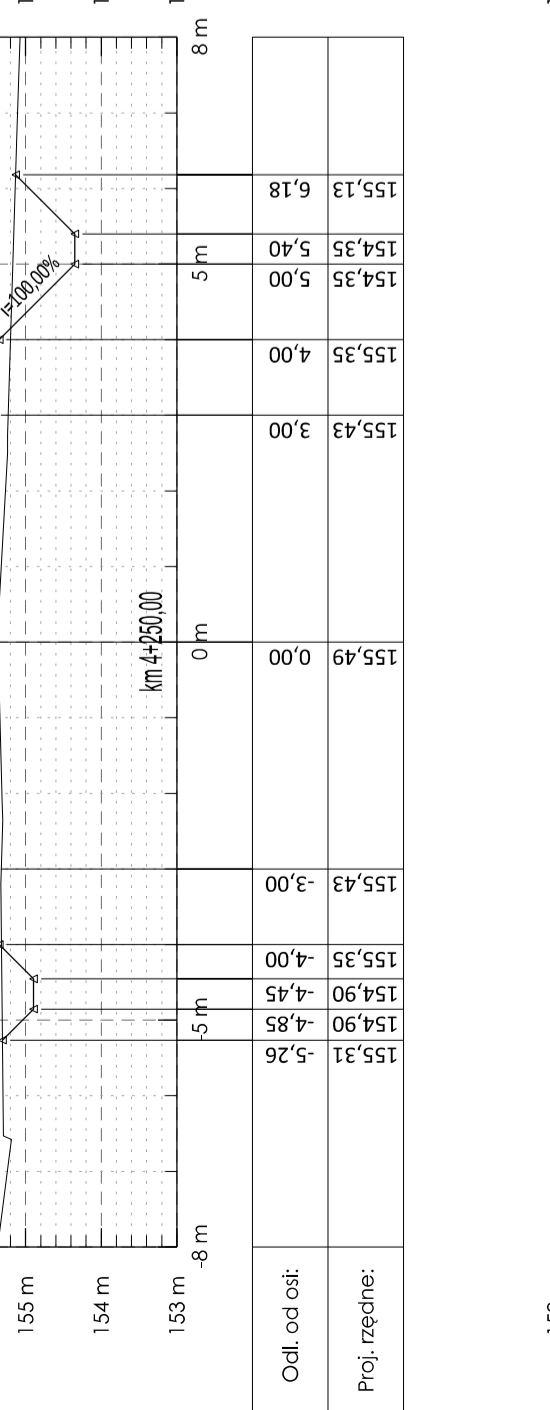
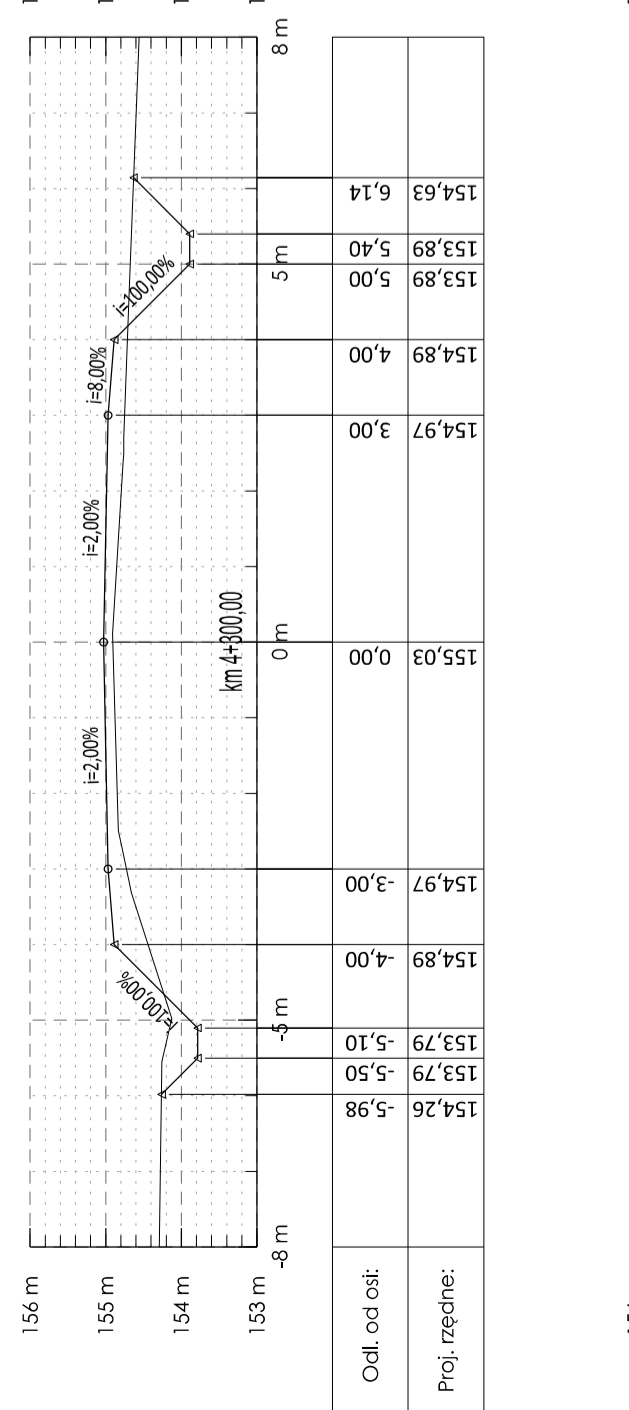
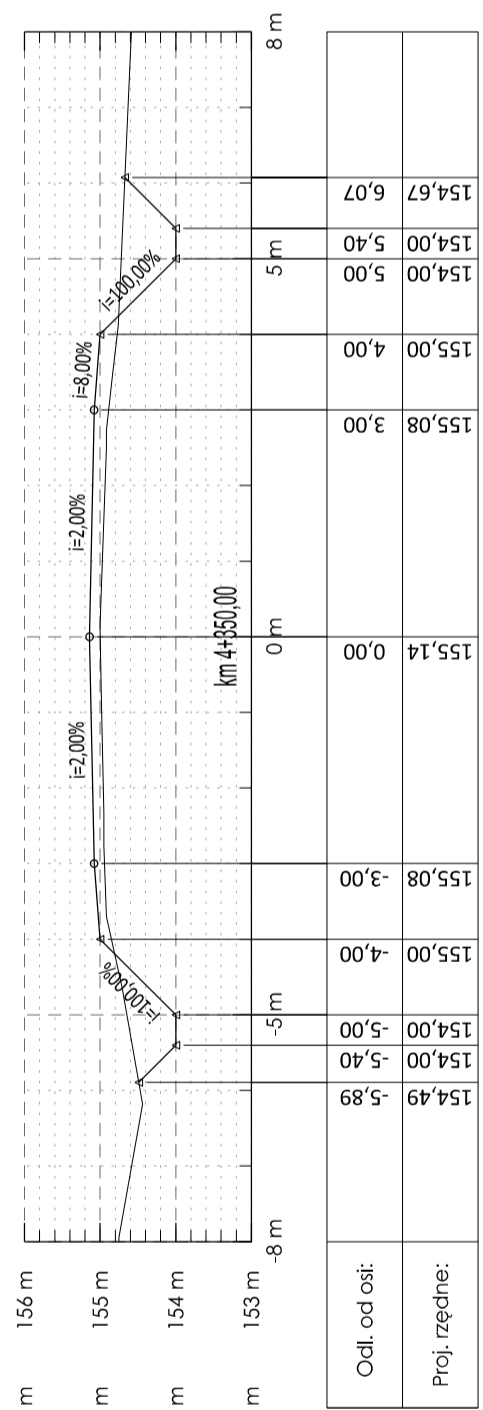
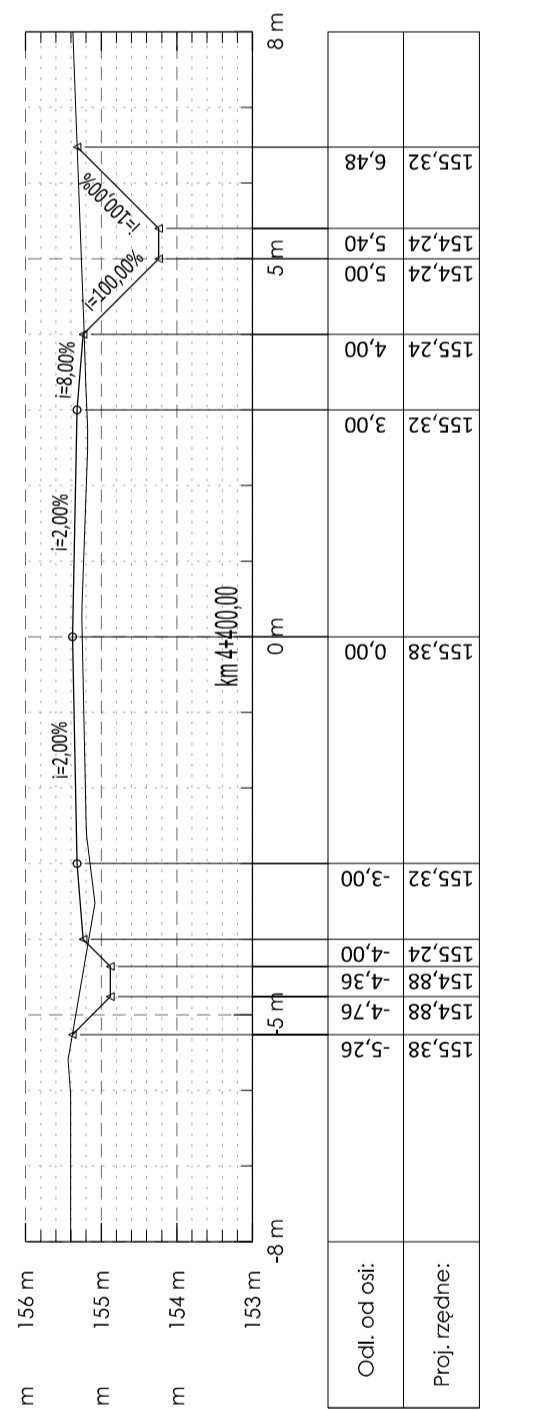
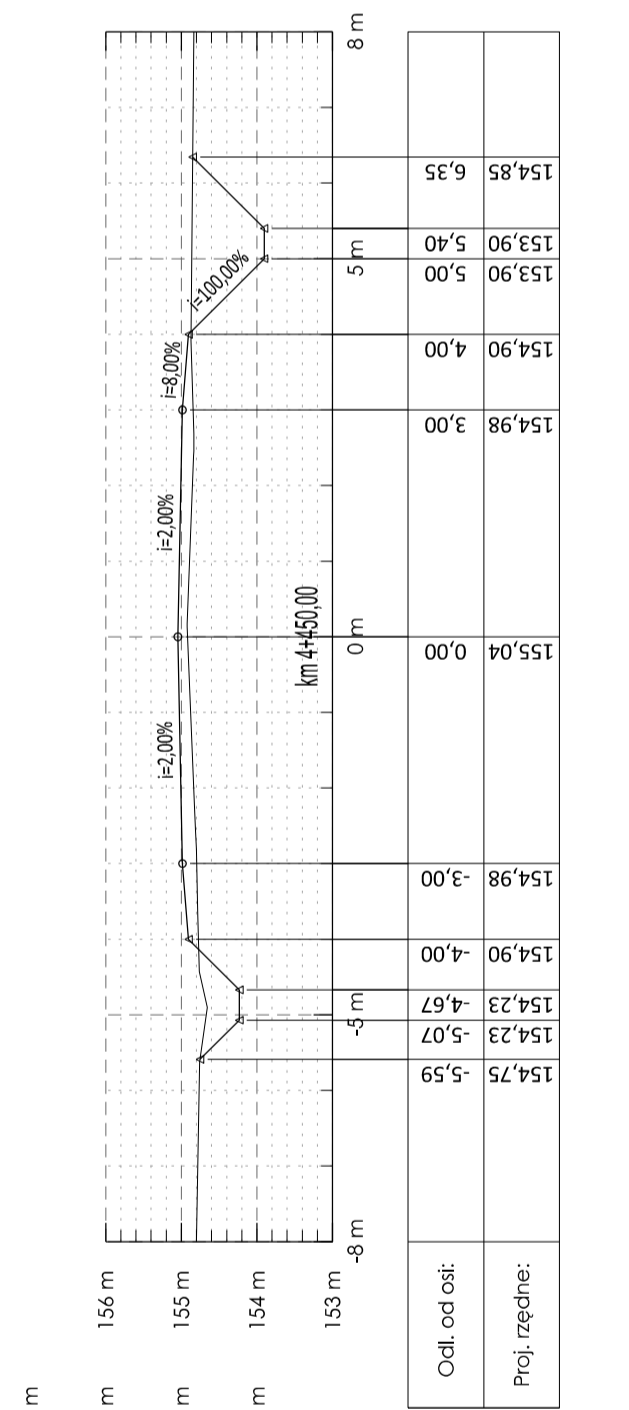
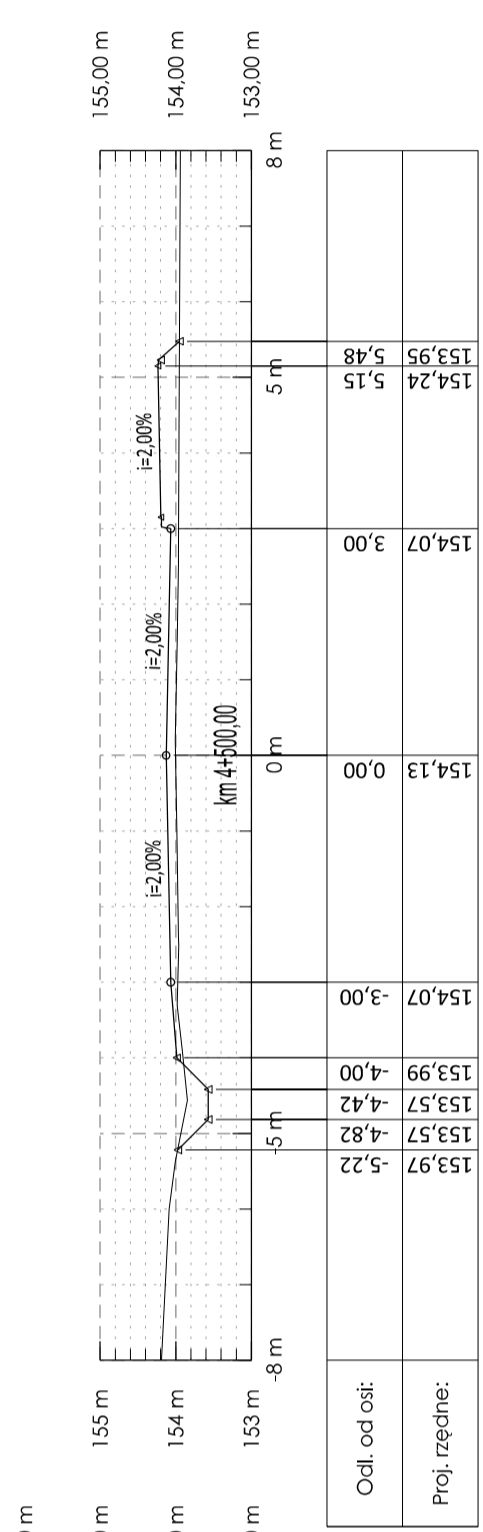
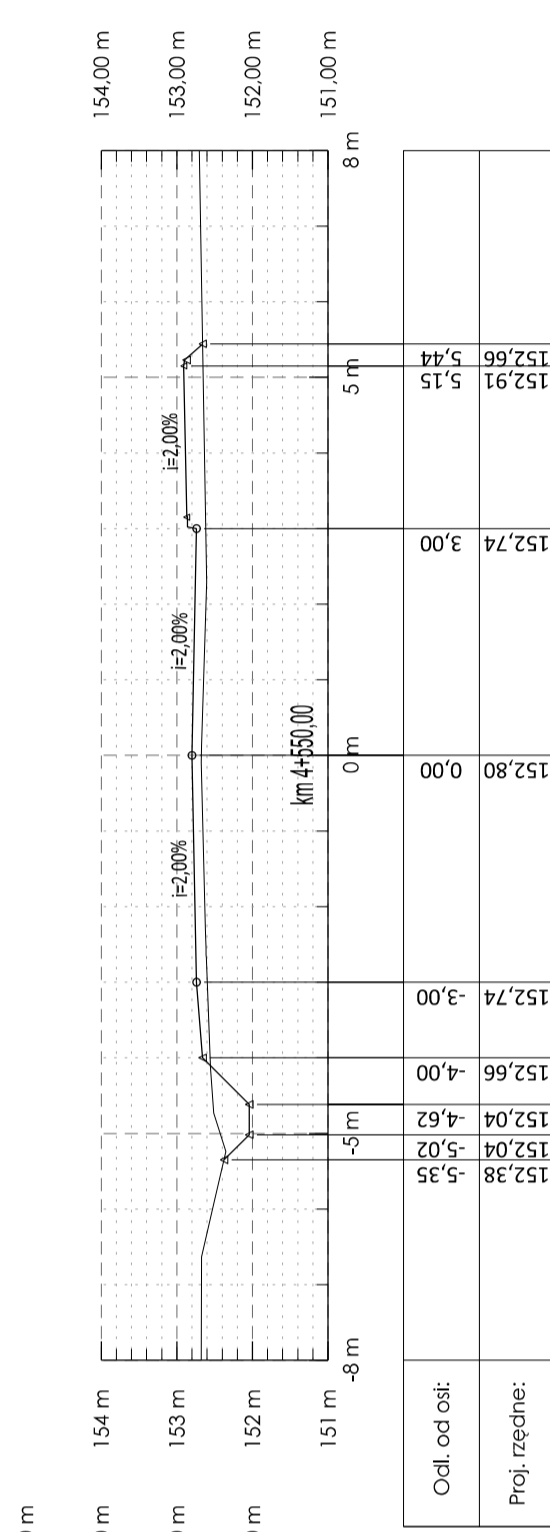
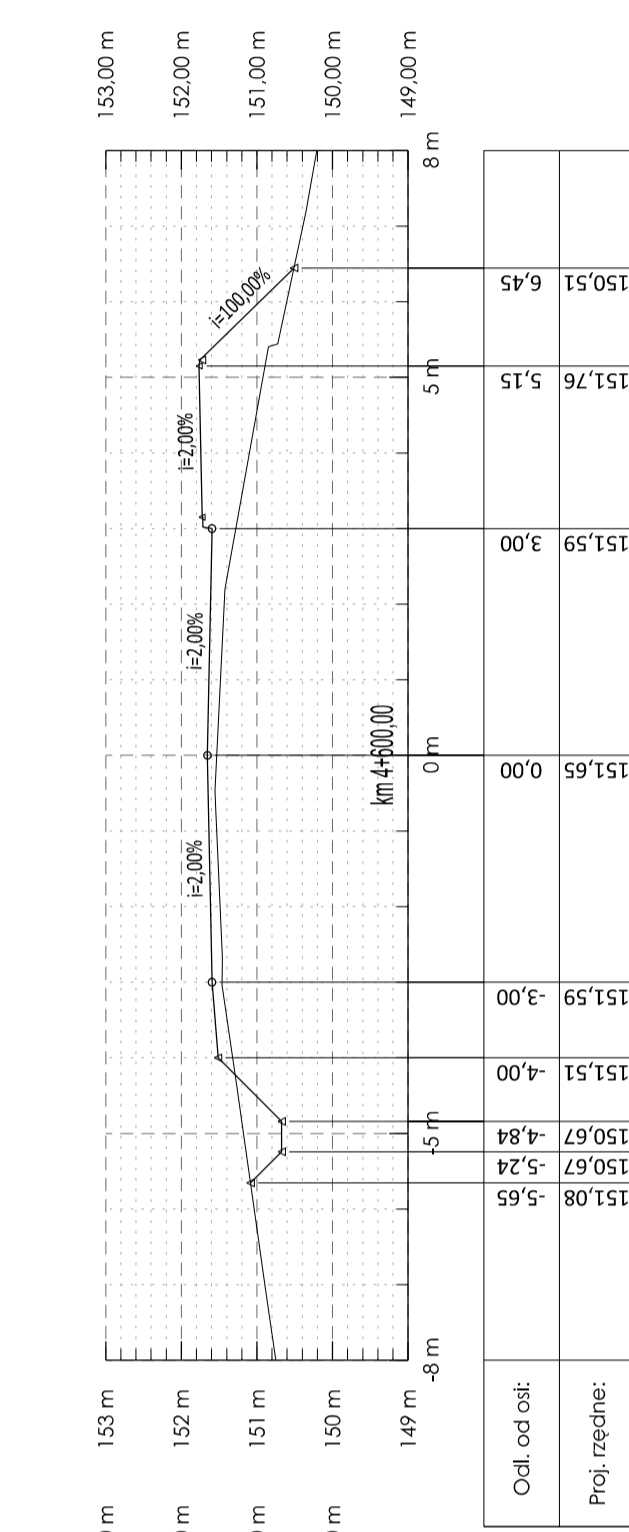

INWESTOR: Starostwo Powiatowe w Grojcu
ul. Piłsudskiego 59
05-600 Grojec

WYKONAWCA: BPI
Biurowy Projektów Infrastrukturalnych
Krzysztof Suliga, ul. Teczowa 3/6, 05-270 Marki
tel. 791 95 65 51, email: biuro@bpi-ko.pl

Faza projektu: PROJEKT BUDOWLANO - WYKONAWCZY

Projektant: mgr inż. Krzysztof Suliga
upr. nr 83/PO/S/12

Sprawdzający: mgr inż. Bartłomiej Małętka
upr. nr MAZ/0405/POD/10

Podpis: [Signature]

Podpis: [Signature]

Tom: TOM-I

Skala rysunku: 1:50

Data: VIII.2017

Nr rysunku: PC-1602-15

Tytuł rysunku: Przekroje charakterystyczne

od km 4+650,00 - do km 4+771,46

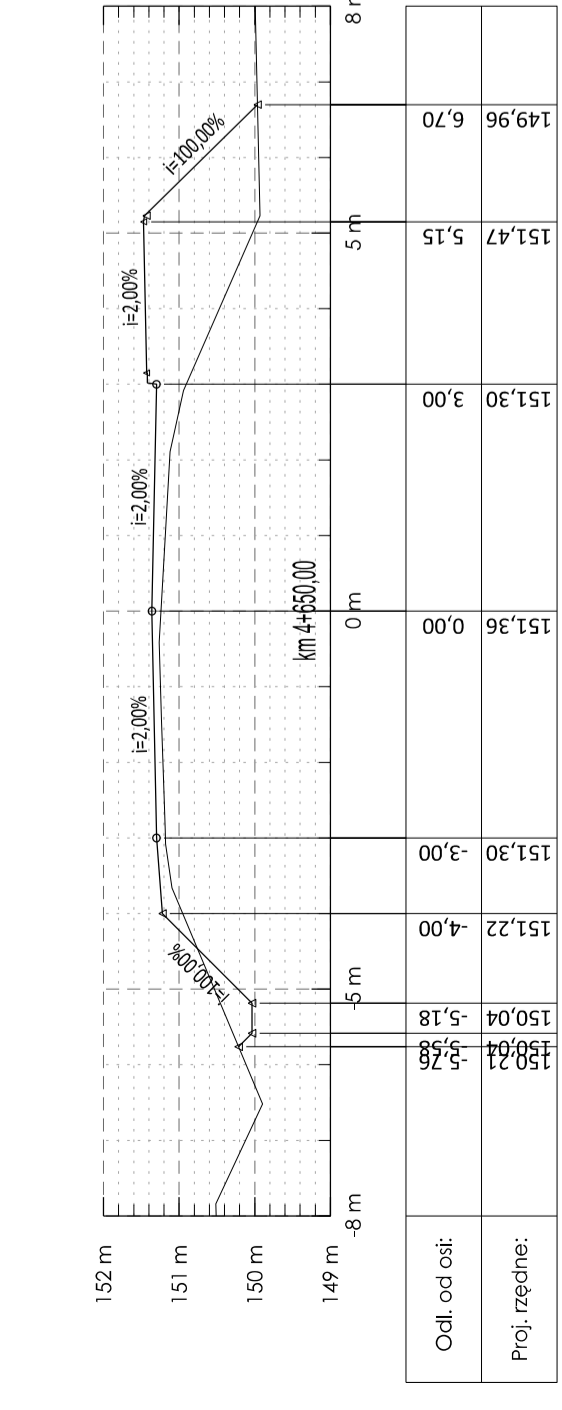
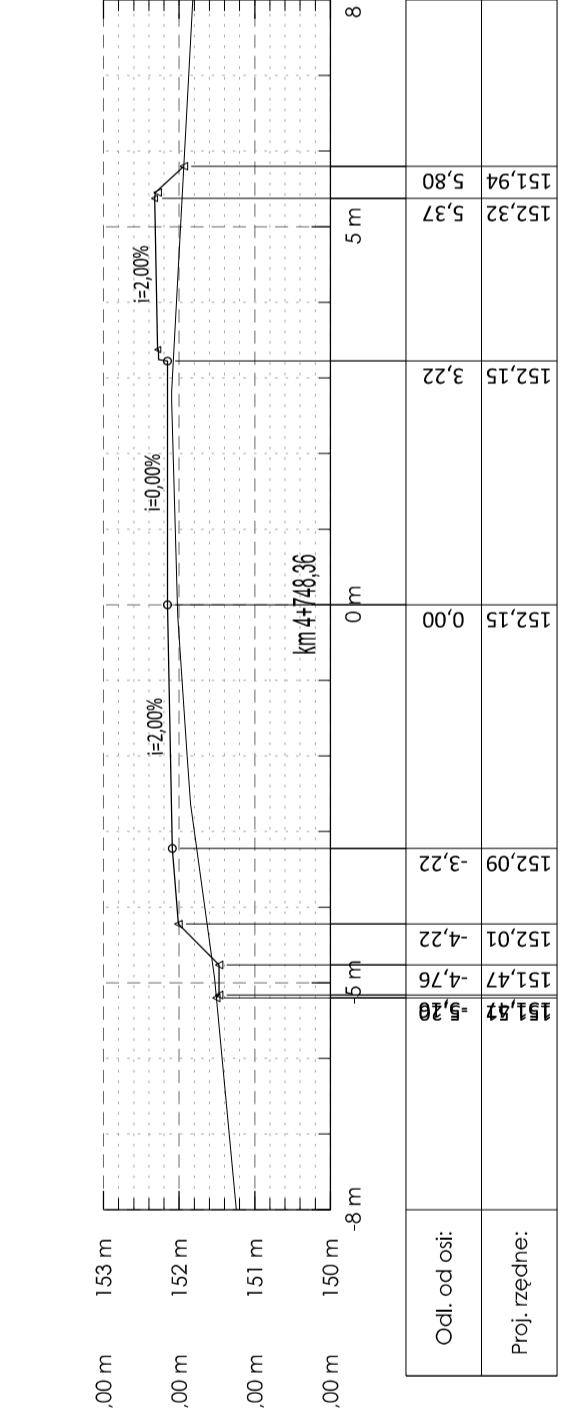
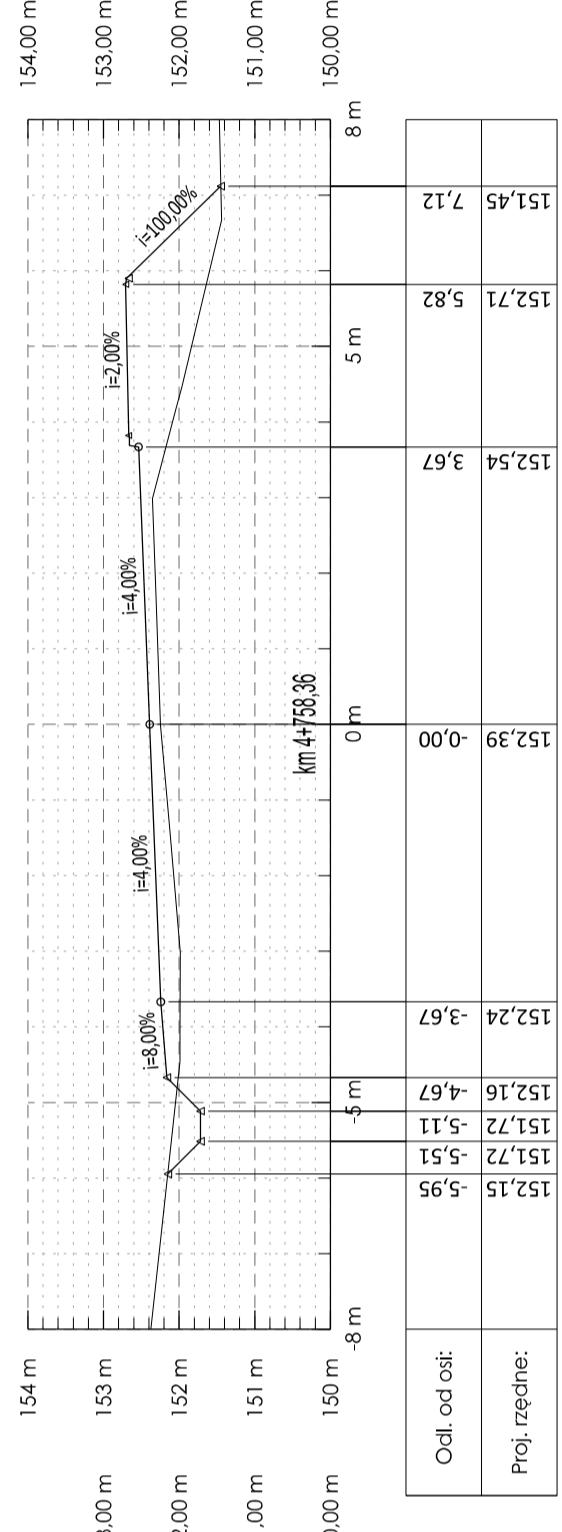
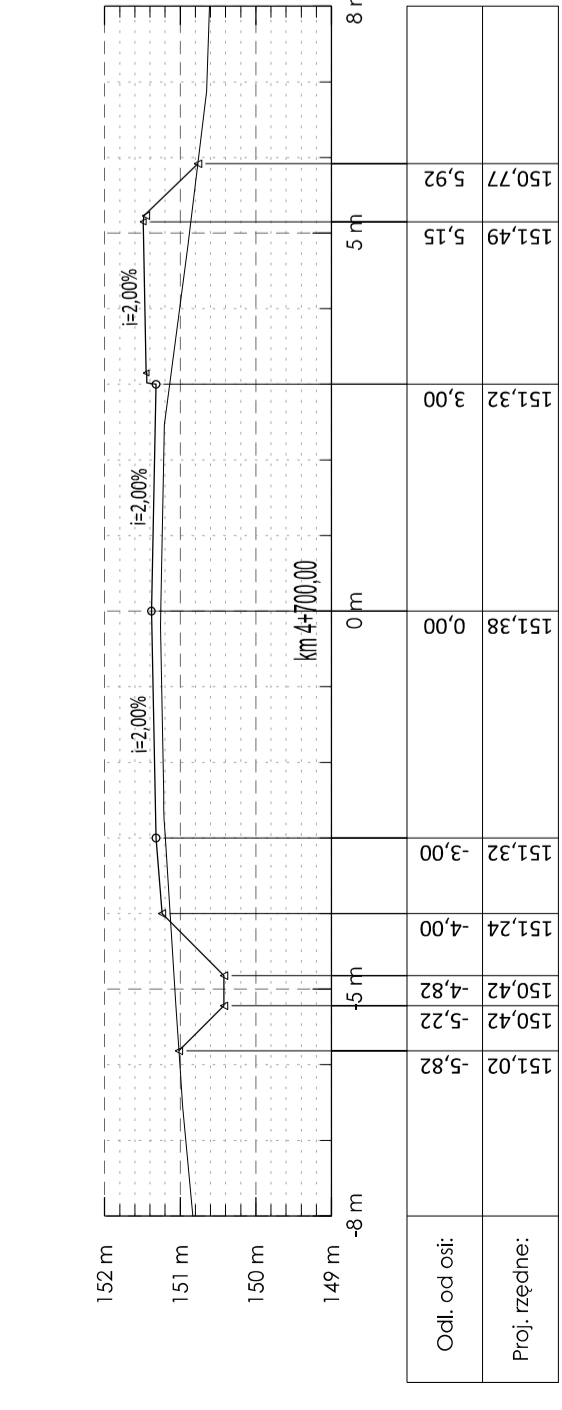
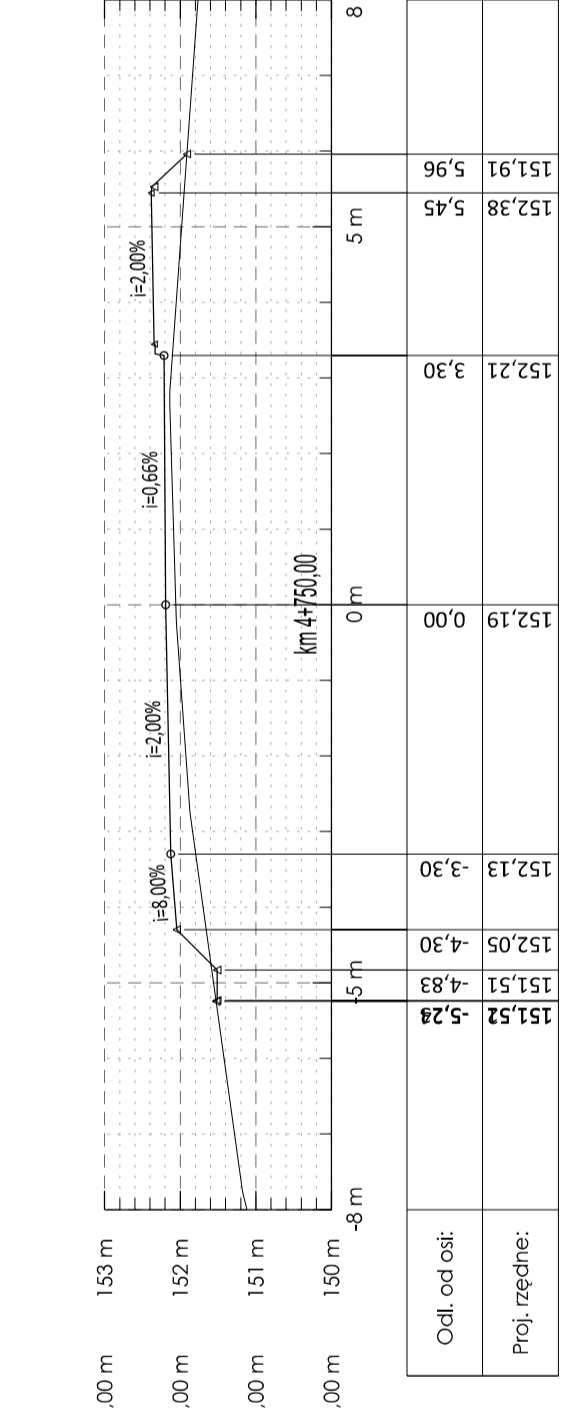
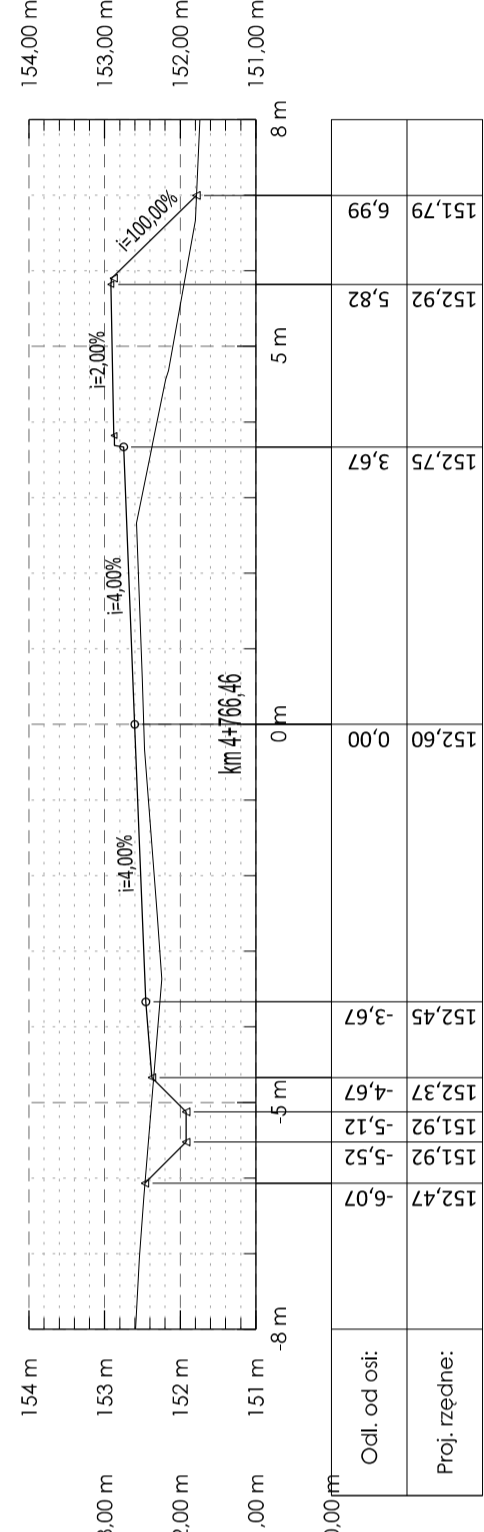
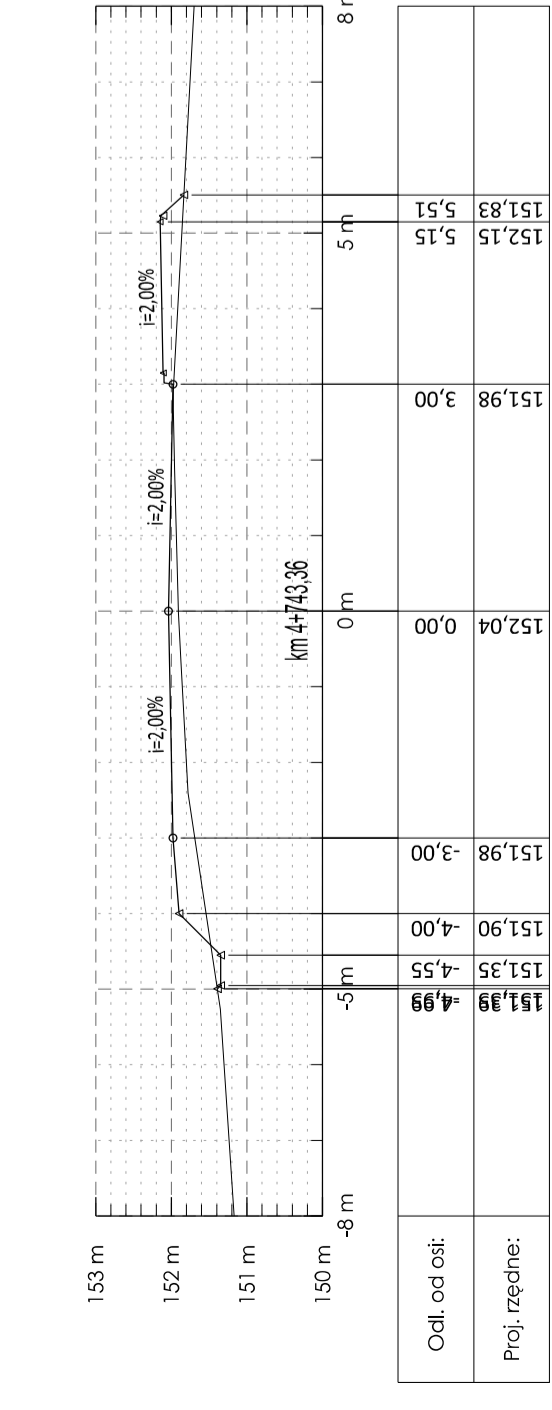
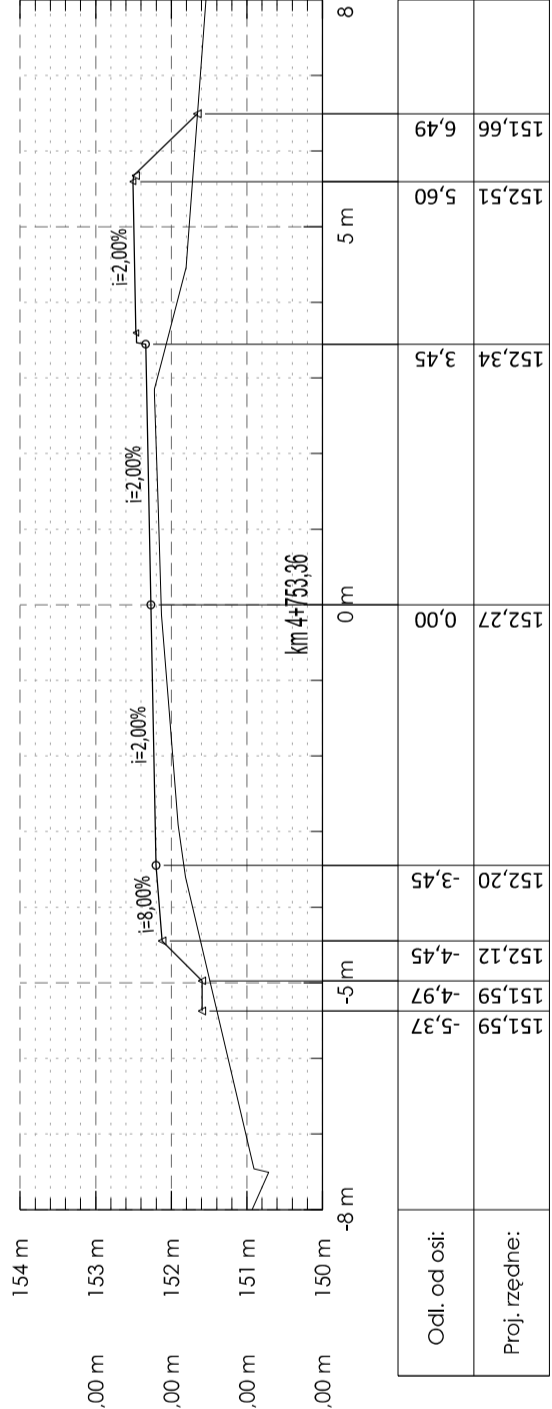
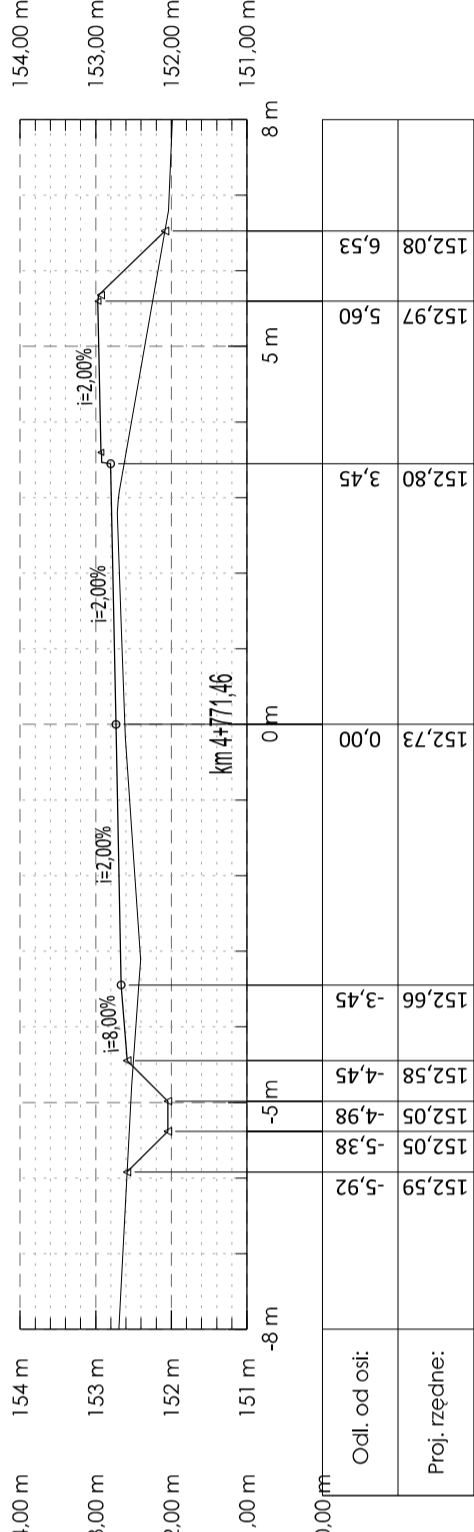

Inwestor: Starostwo Powiatowe w Grojcu
ul. Piłsudskiego 59
05-600 Grojec

Wykonawca: BPI
Biuro Projektów Infrastrukturalnych
Krzysztof Suliga, ul. Teczowa 3/6, 05-270 Marki
tel. 791 95 65 51, email: biuro@bpi-ko.pl

Faza projektu: PROJEKT BUDOWLANO - WYKONAWCZY

Inżynieria ruchu: mgr inż. Krzysztof Suliga
upr. nr 63/PO/S/12

Sprawdzający: mgr inż. Bartłomiej Małętka
upr. nr MAZ/0405/POD/10

Tom: TOM-I

Skala rysunku: 1:50

Data: VIII.2017

Typul rysunku: Przekroje charakterystyczne

Nr rysunku: PC-1602-16

od km 4+776,46 - do km 5+100,00

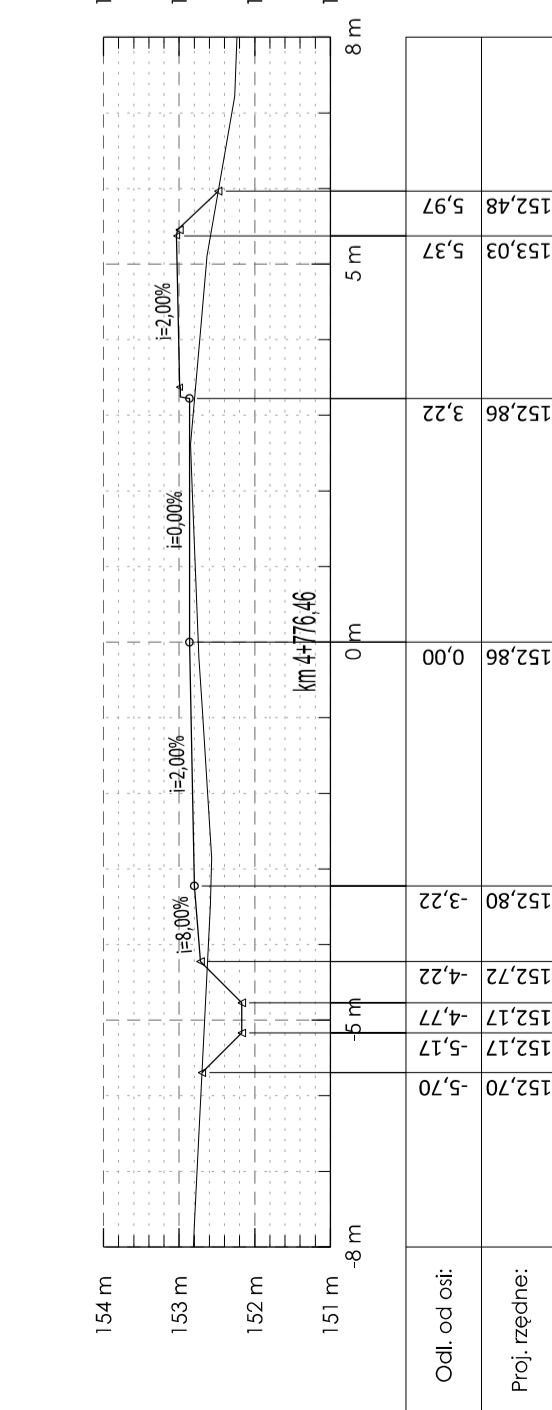
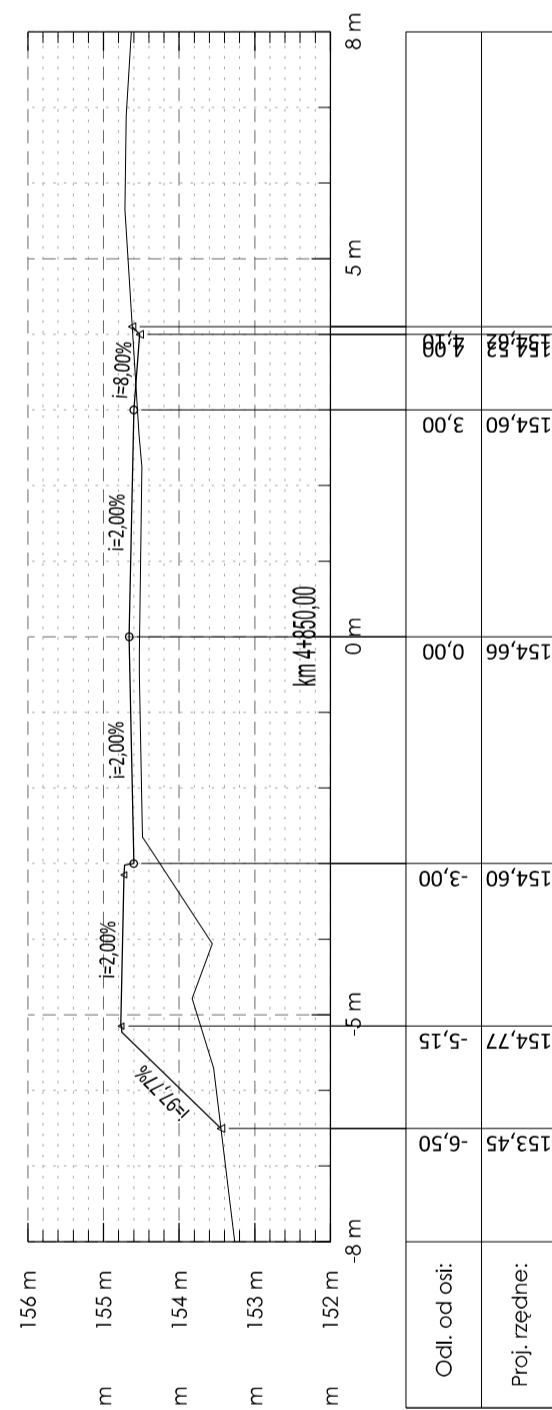
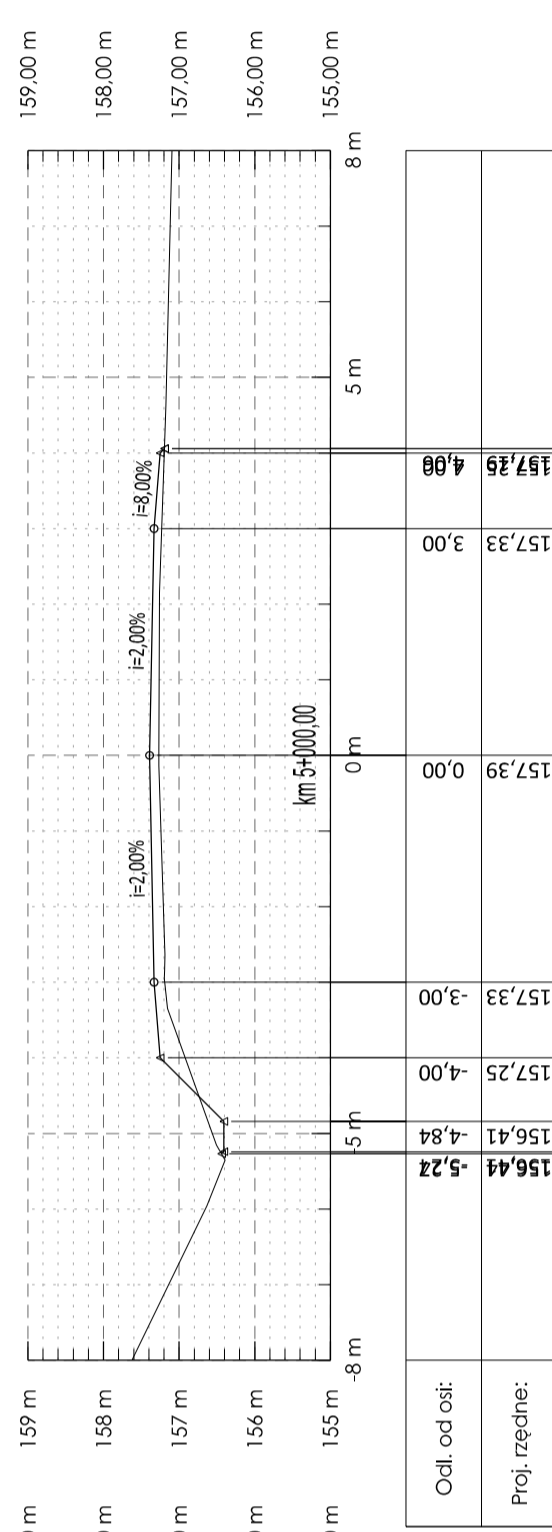
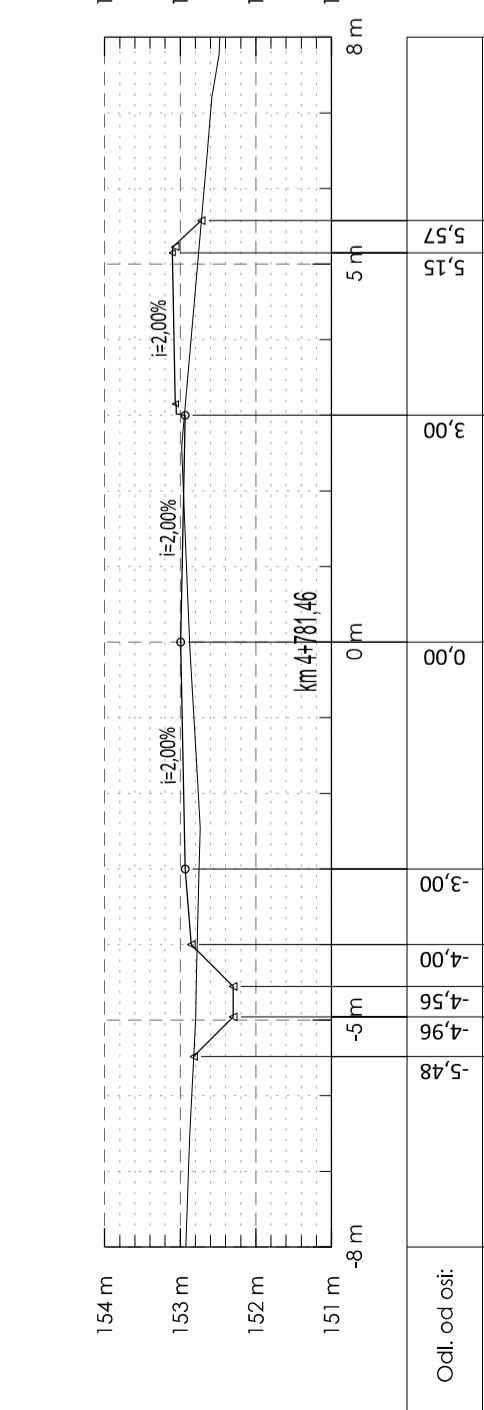
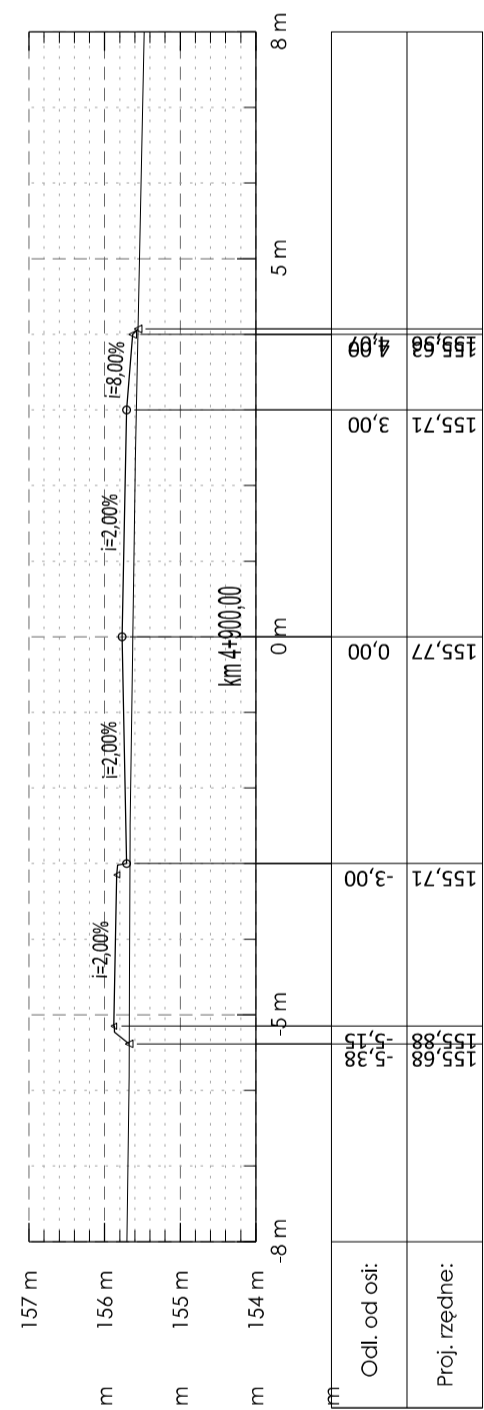
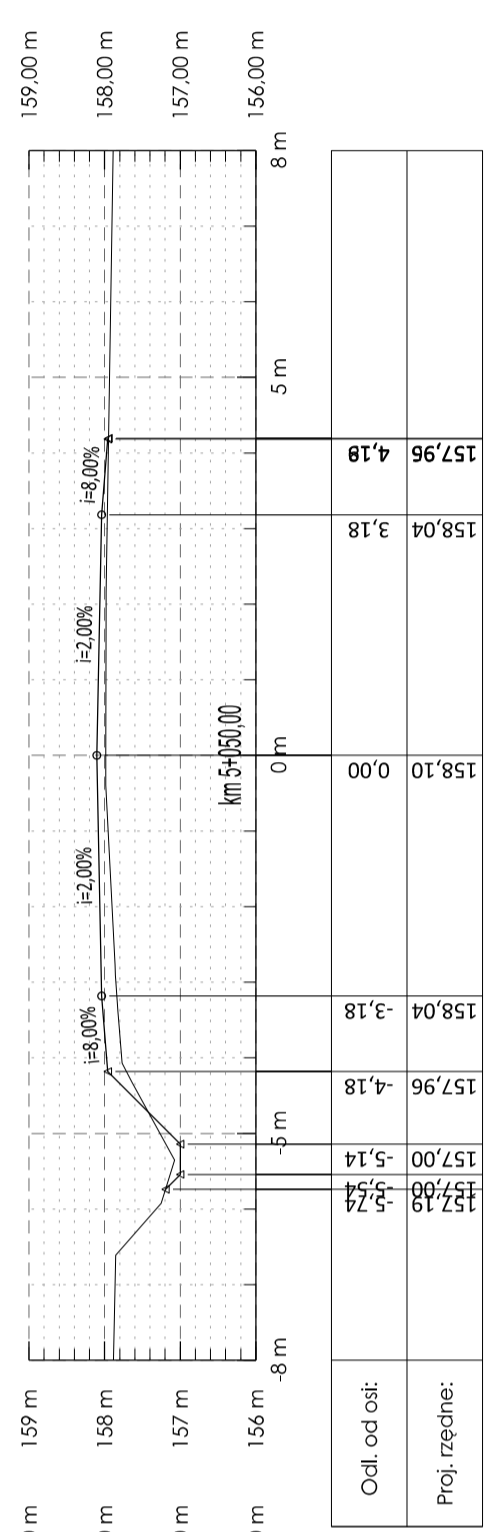
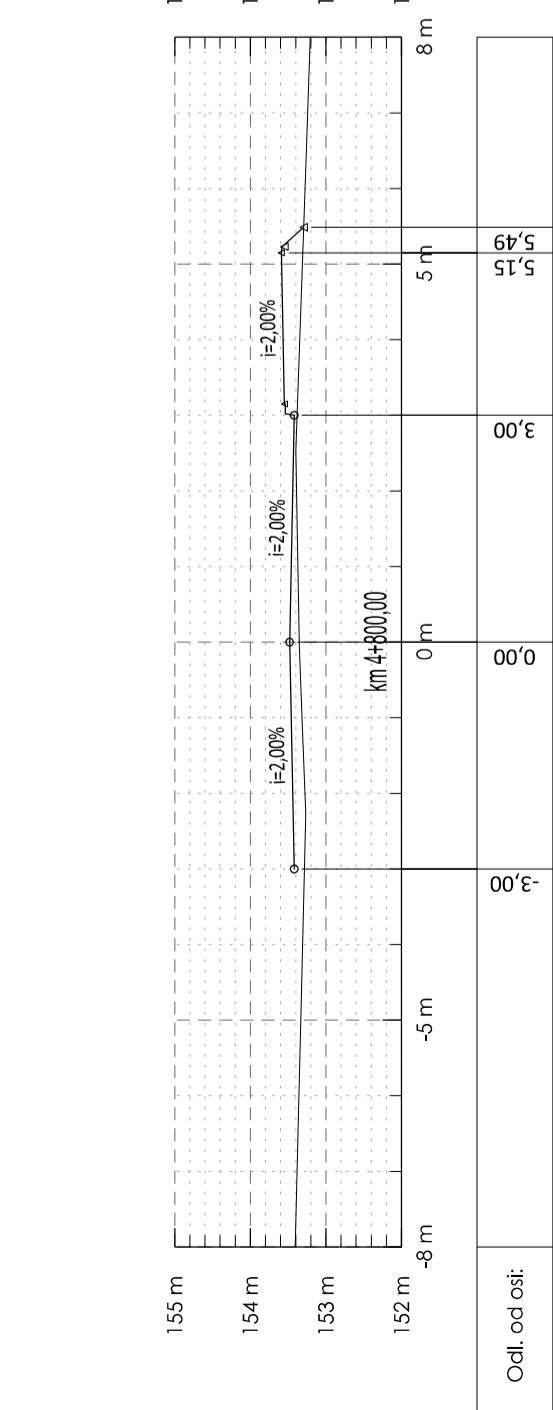
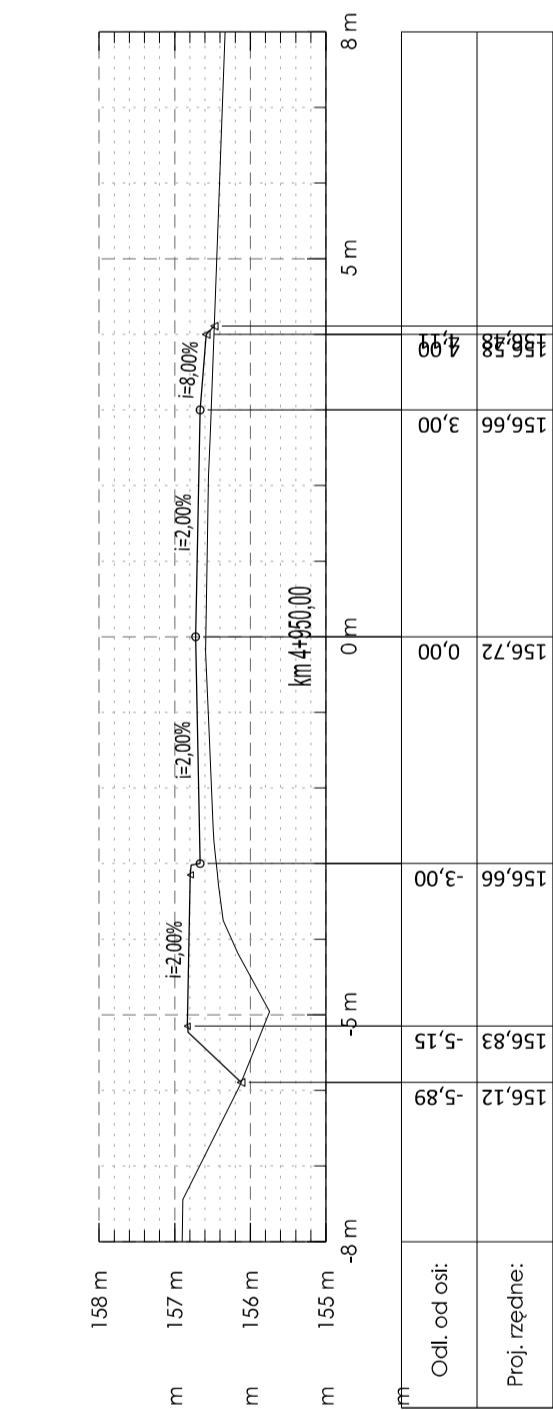
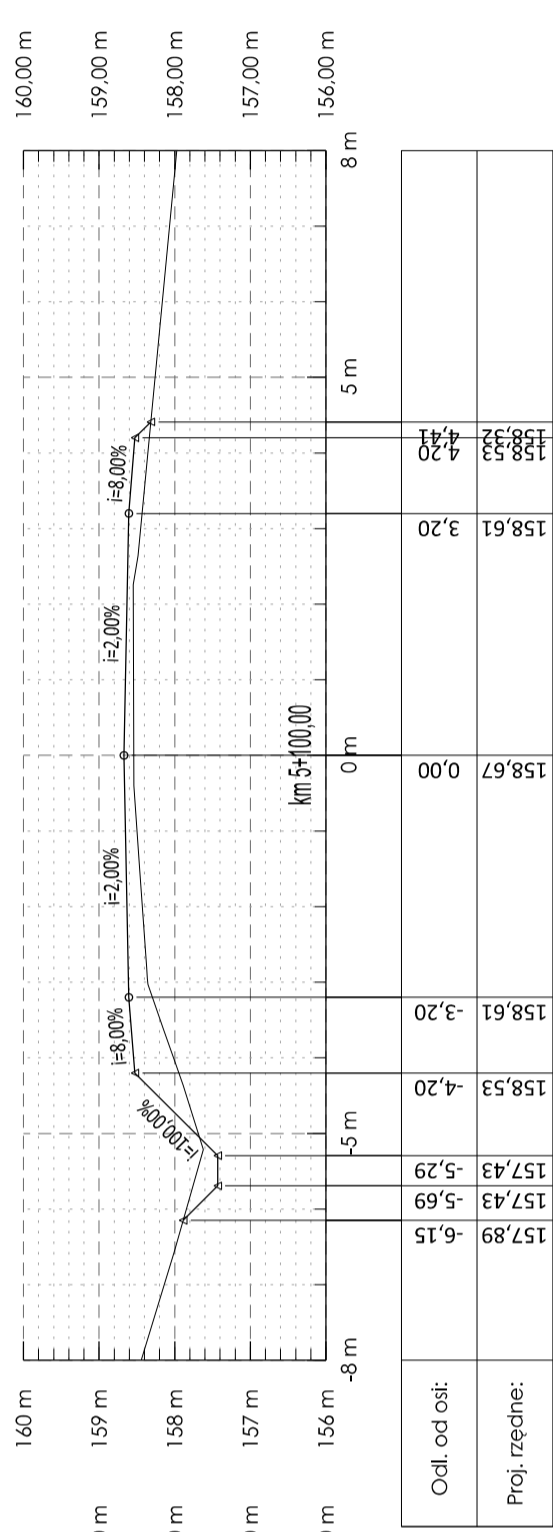

Inwestor: Starostwo Powiatowe w Grójcu
ul. Piłsudskiego 59
05-600 Grójec

Wykonawca: BPI
Biurowo Projektów Infrastrukturalnych
Krzysztof Suliga, ul. Teczowa 3/6, 05-270 Marki
tel. 791 95 65 51, email: biuro@bpi-ko.pl

Faza projektu: PROJEKT BUDOWLANO - WYKONAWCZY

Inżynieria ruchu: mgr inż. Krzysztof Suliga
upr. nr 63/PO/S/12

Sprawdzający: mgr inż. Bartłomiej Małętka
upr. nr 1042/04/5/PO/07/10

Tom: TOM-I

Skala rysunku: 1:50

Data: VIII.2017

Tytuł rysunku: Przekroje charakterystyczne

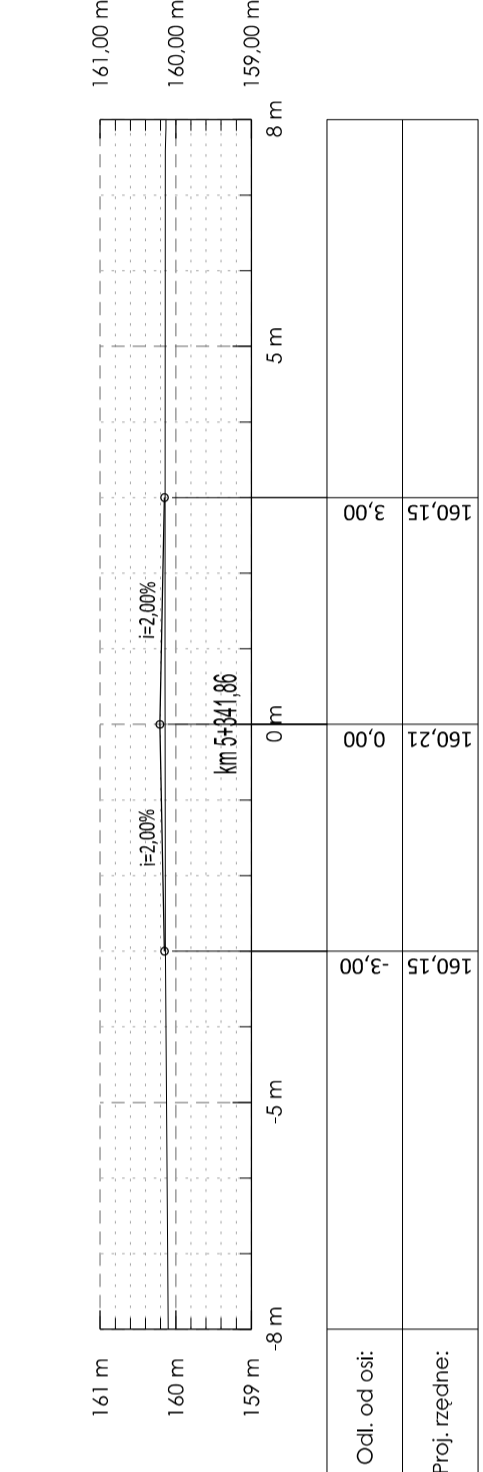
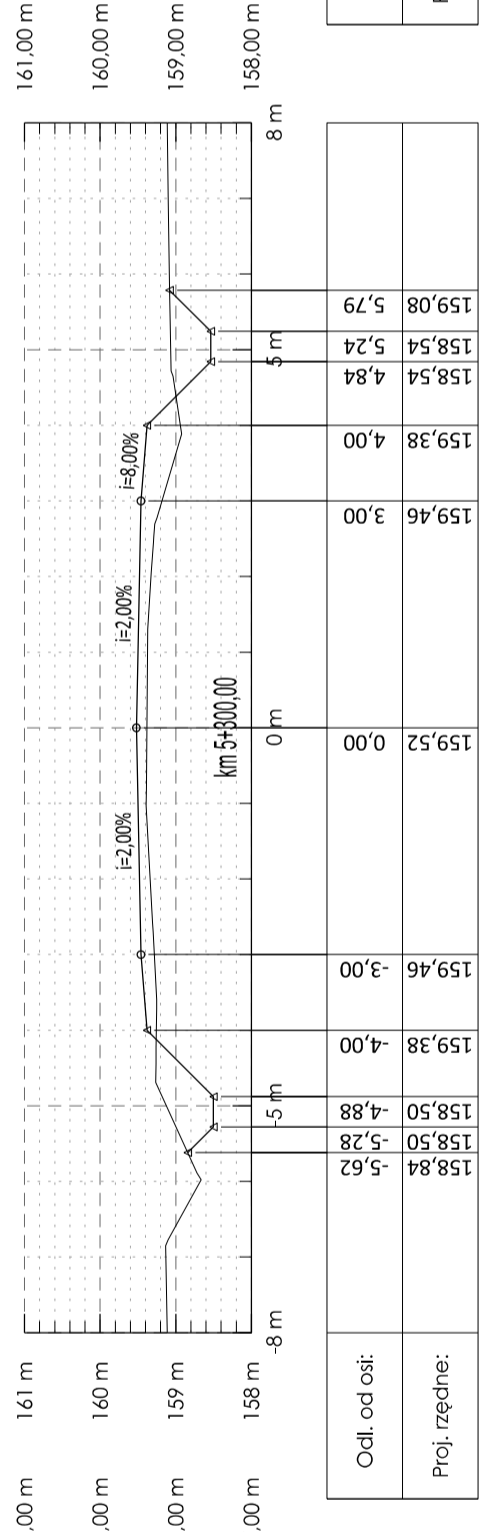
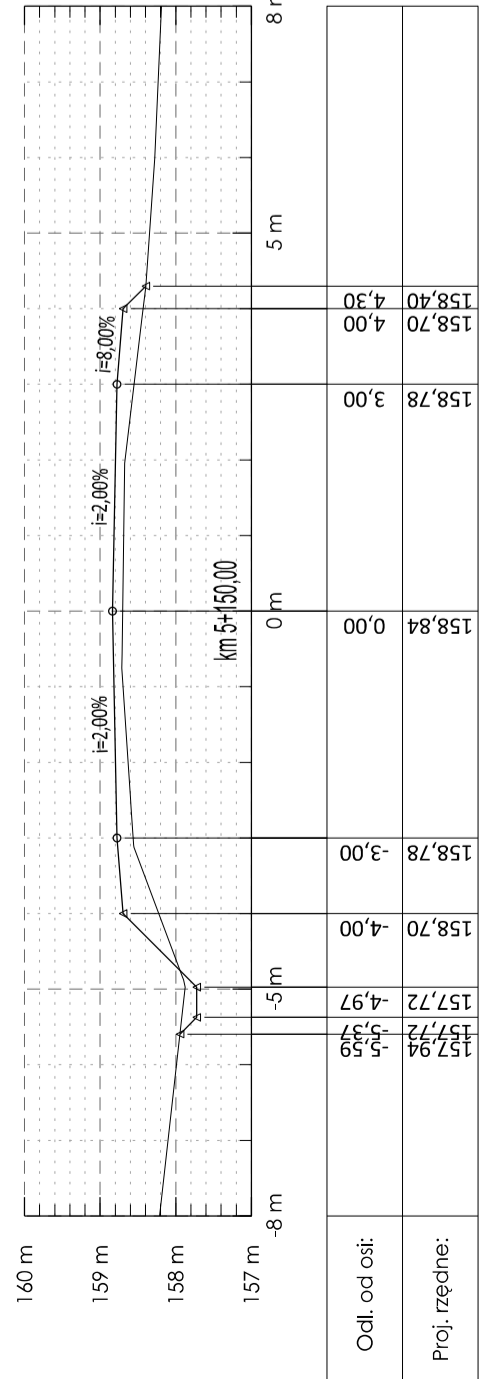
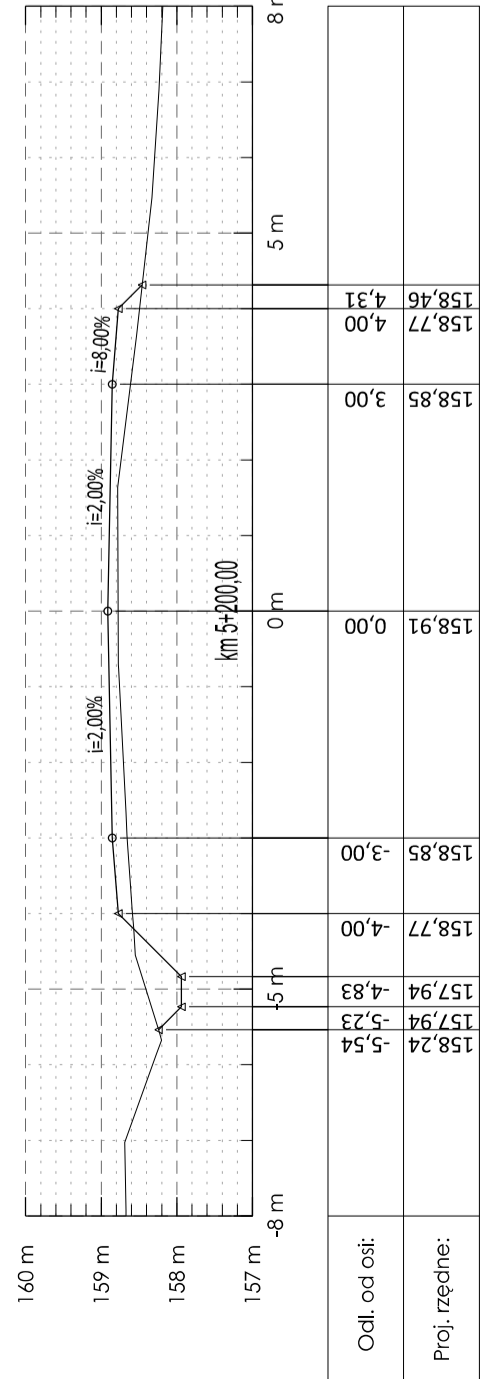
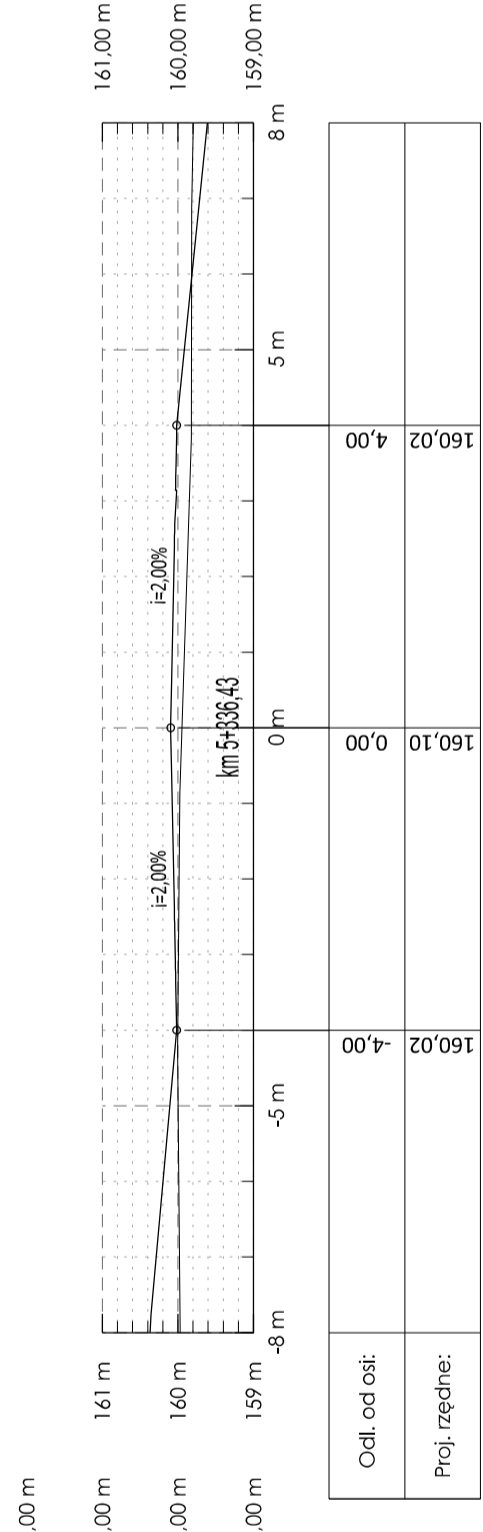
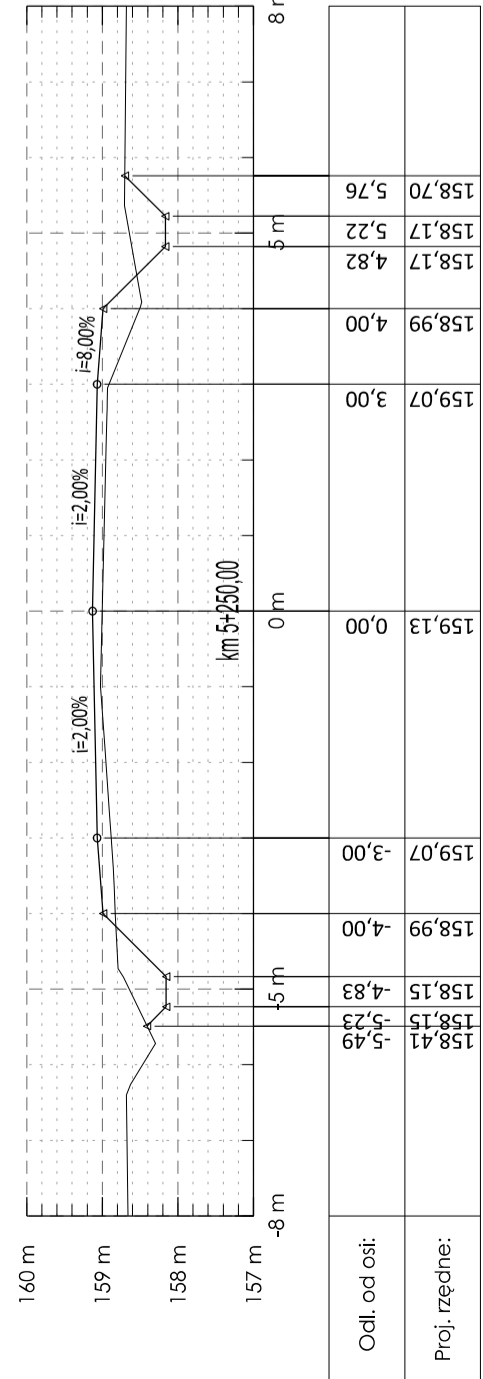

Nr rysunku: PC-1602-17

od km 5+150,00 - do km 5+341,86

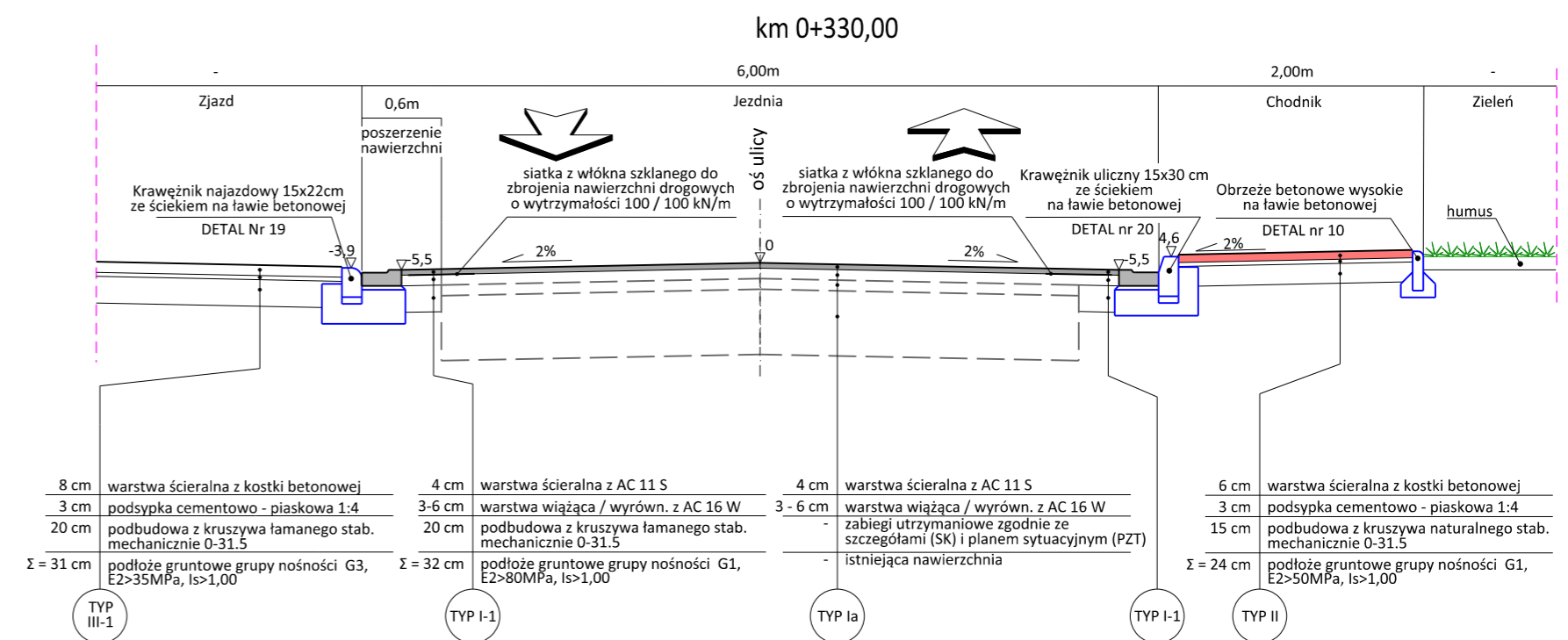
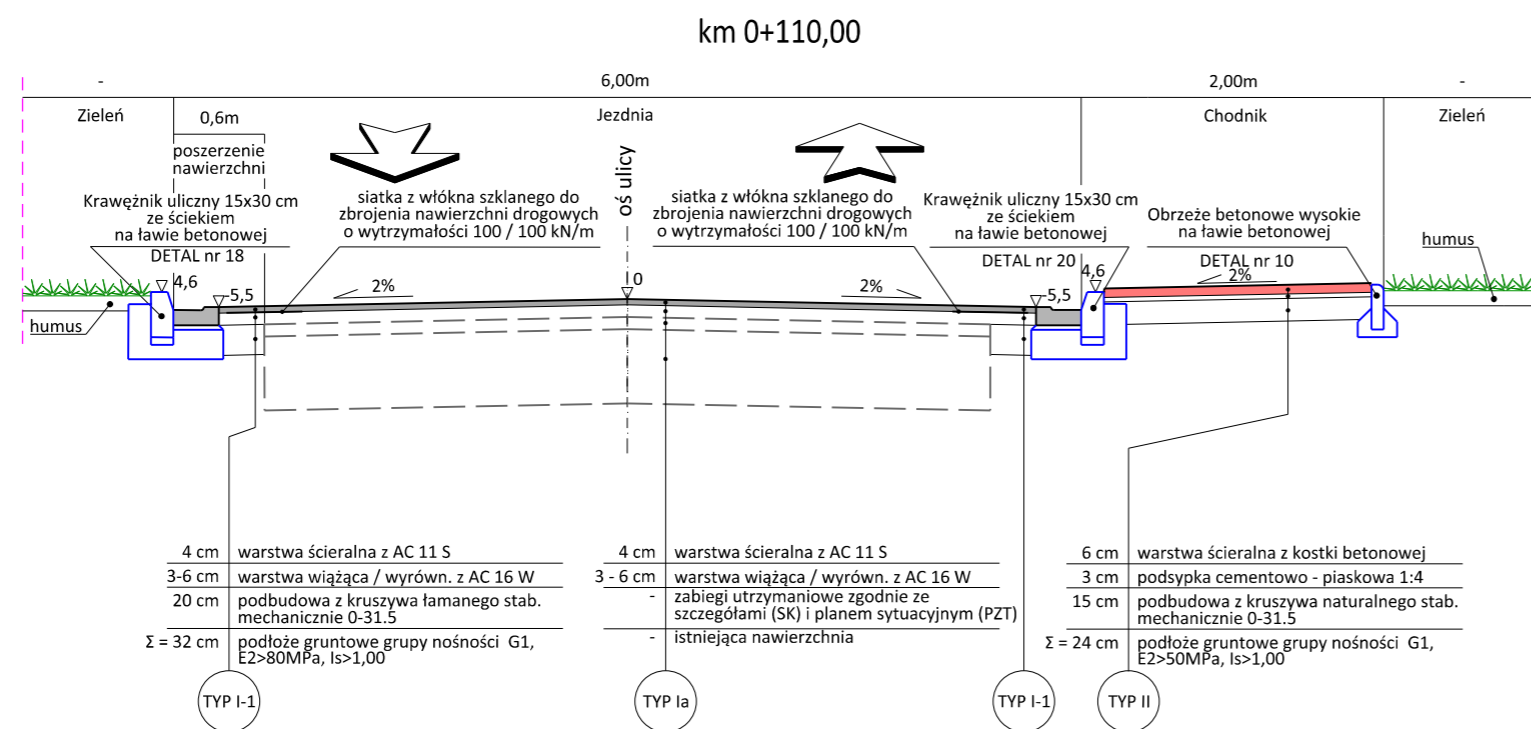
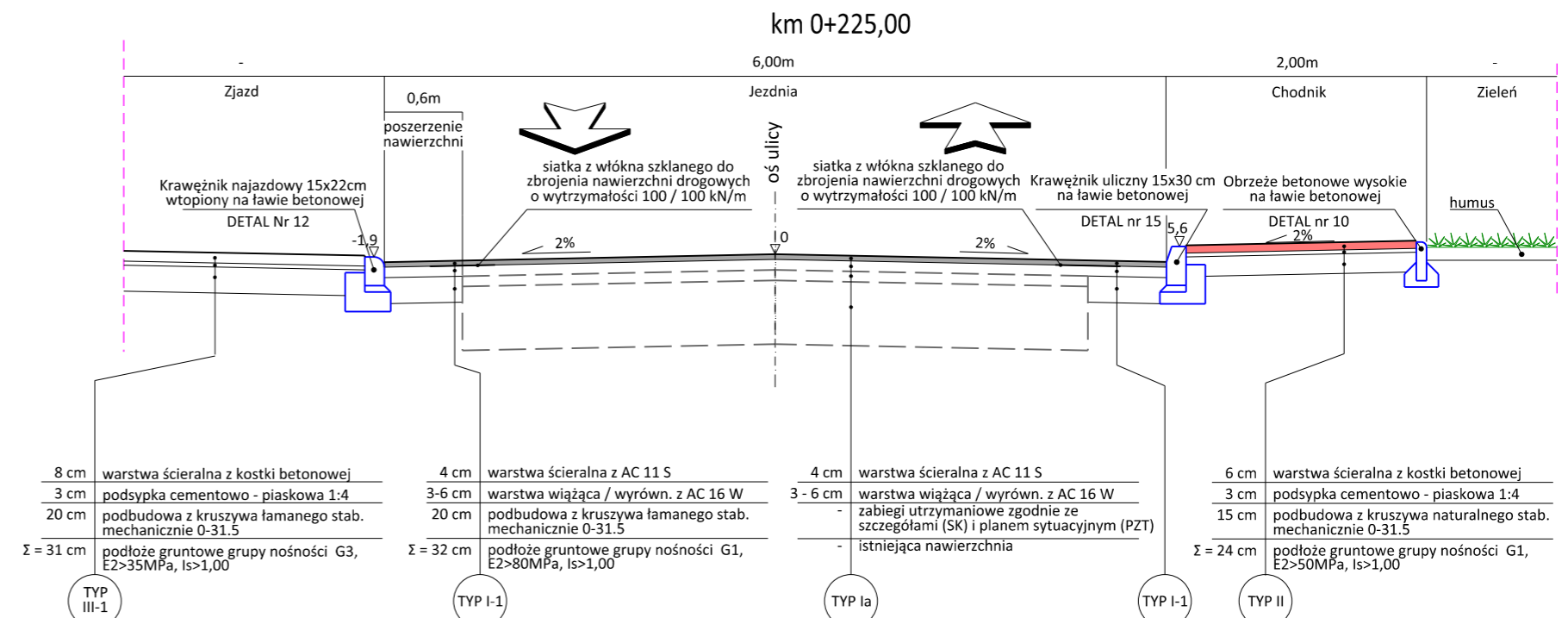
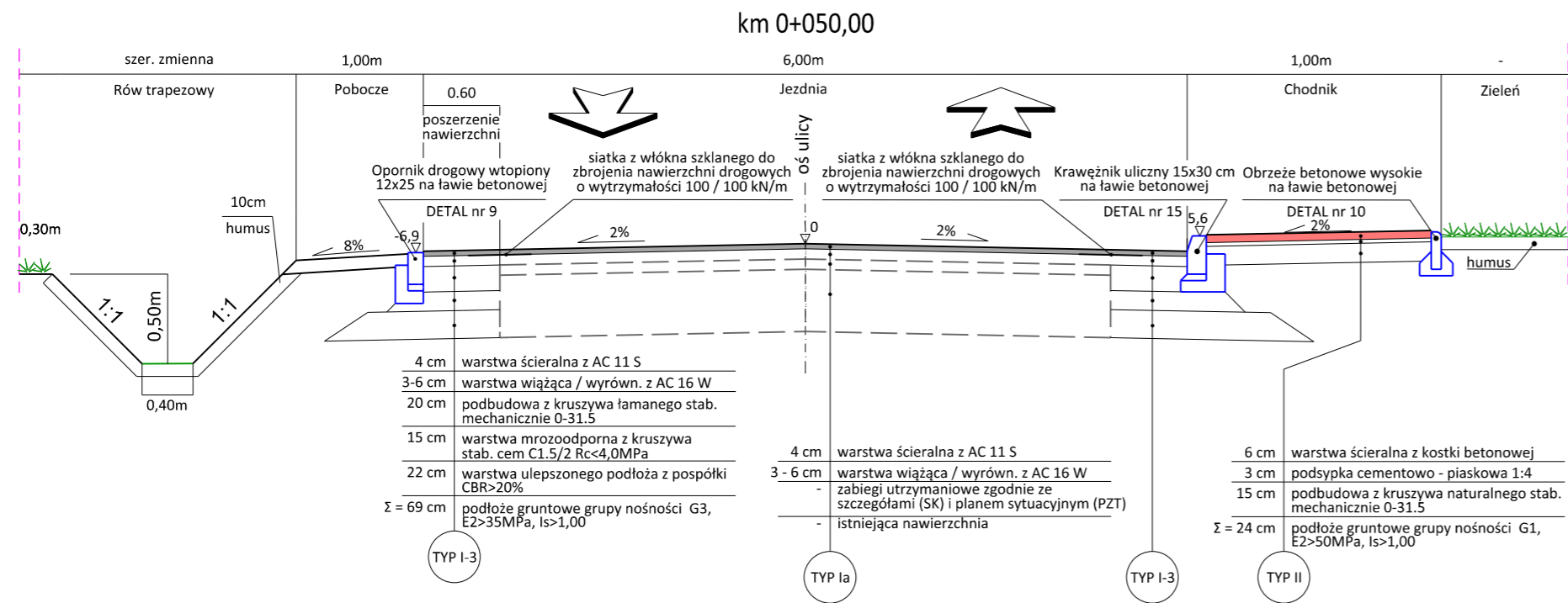

Wykonawca: Starostwo Powiatowe w Grojcu ul. Piłsudskiego 59 05-600 Grojciec	Faza projektu: PROJEKT BUDOWLANO - WYKONAWCZY	
	Projektant: mgr inż. Krzysztof Suliga upr. nr 63/PDS/12	Podpis:
	Sprawdzający: mgr inż. Bartłomiej Małętka upr. nr 1042/PDS/10	Podpis:
	Tom: TOM-I	Data: VIII.2017
Skala rysunku: 1:50	Nr rysunku: PC-1602-18	Tytuł rysunku: Przekroje charakterystyczne
Investor: Biuro Projektów Infrastrukturalnych Krzysztof Suliga, ul. Teczowa 3/6, 05-270 Marki tel. 791 95 65 51, email: biuro@bpi-ka.pl	Investycja: PRZEBUDOWA DRÓG POWIATOWYCH NR 1602W WILCZORUDA - MICHROW I 1601W PNIEWY - REMBERTÓW	



Inwestor:  Starostwo Powiatowe w Grójcu ul. Piłsudskiego 59 05-600 Grójec		Faza projektu: PROJEKT BUDOWLANO - WYKONAWCZY		
Wykonawca:  Biuro Projektów Infrastrukturalnych Krzysztof Suliga, ul. Tęczowa 3/6, 05-270 Marki tel. 791 95 65 51, email: biuro@bpi-ks.pl		Inżynieria ruchu: Projektant: mgr inż. Krzysztof Suliga upr. nr 83/DOS/12	Podpis: 	
		Sprawdzający: mgr inż. Bartłomiej Małetka upr. nr MAZ/0405/POOD/10	Podpis: 	
Inwestycja: PRZEBUDOWA DRÓG POWIATOWYCH NR 1602W WILCZORUDA - MICHRÓW I 1601W PNIEWY - REMBERTÓW		Tom: TOM I	Skala rysunku: 1:50	Data: VIII.2017
		Tytuł rysunku: Przekroje konstrukcyjne		Nr rysunku: PK-1601-01

km 0+345,00

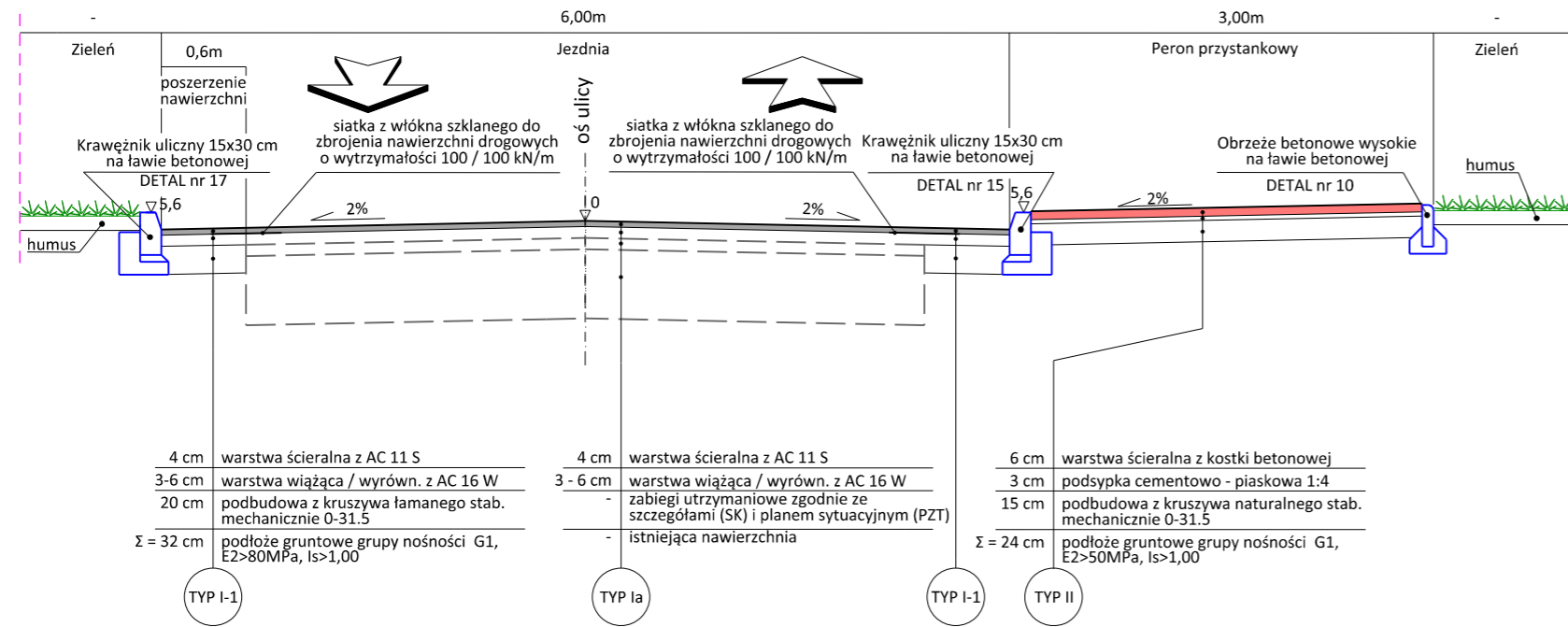

km 0+600,00

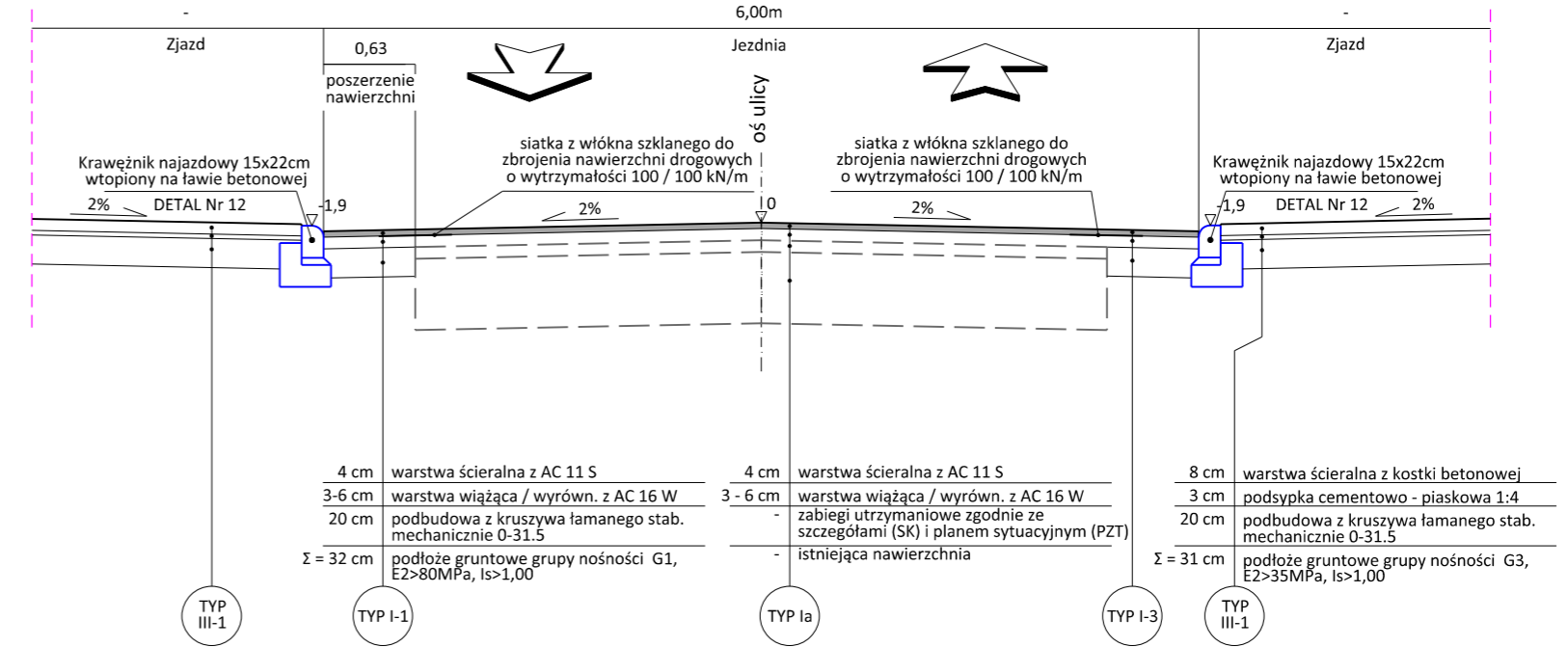

km 0+550,00

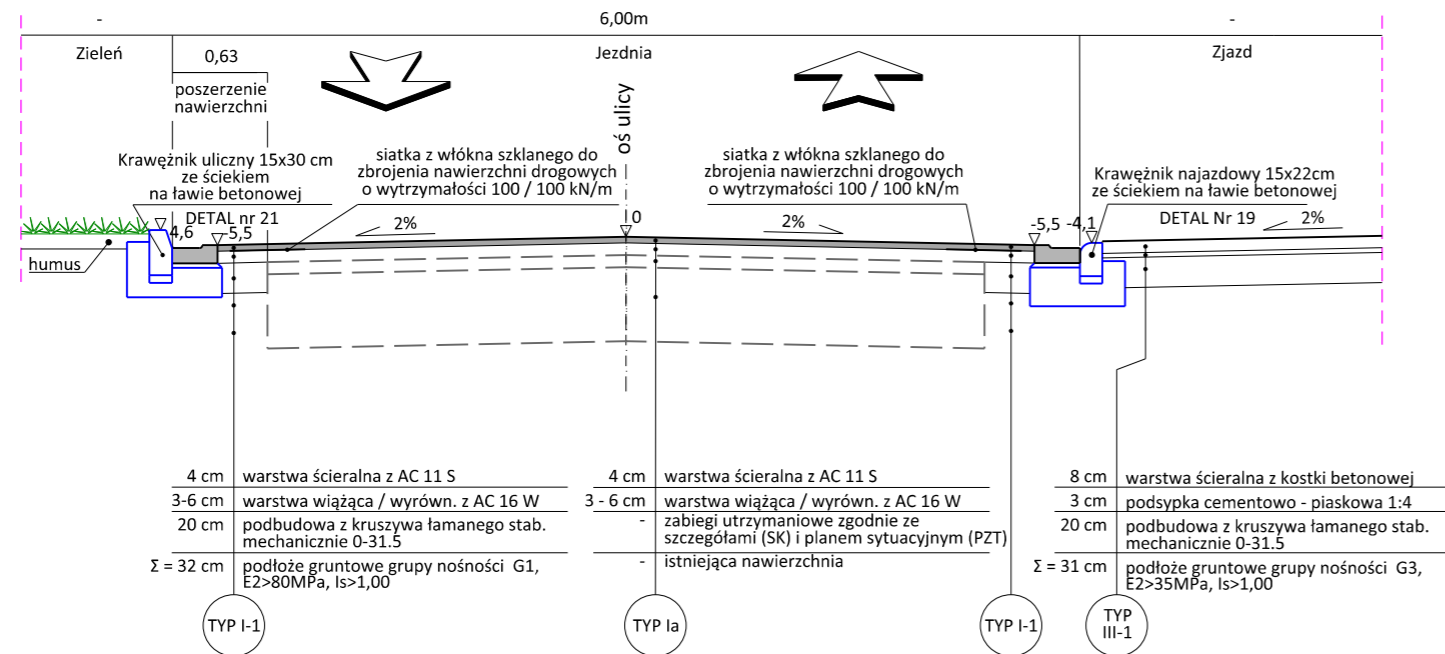



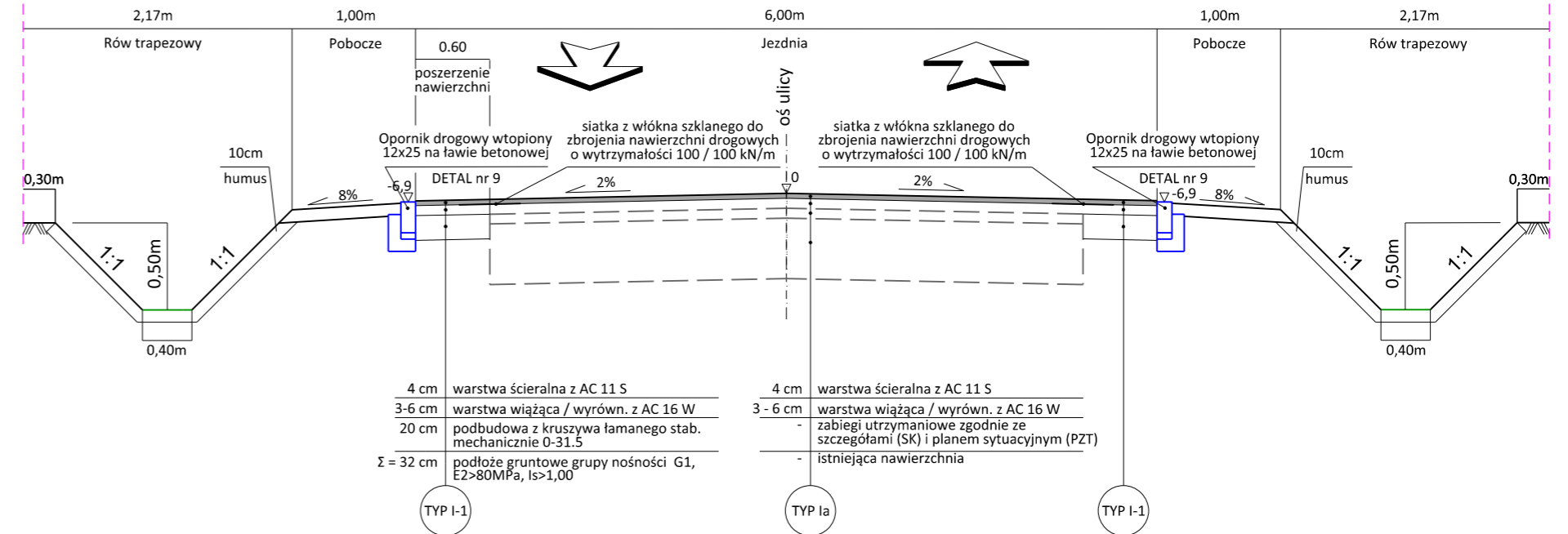

km 0+630,00

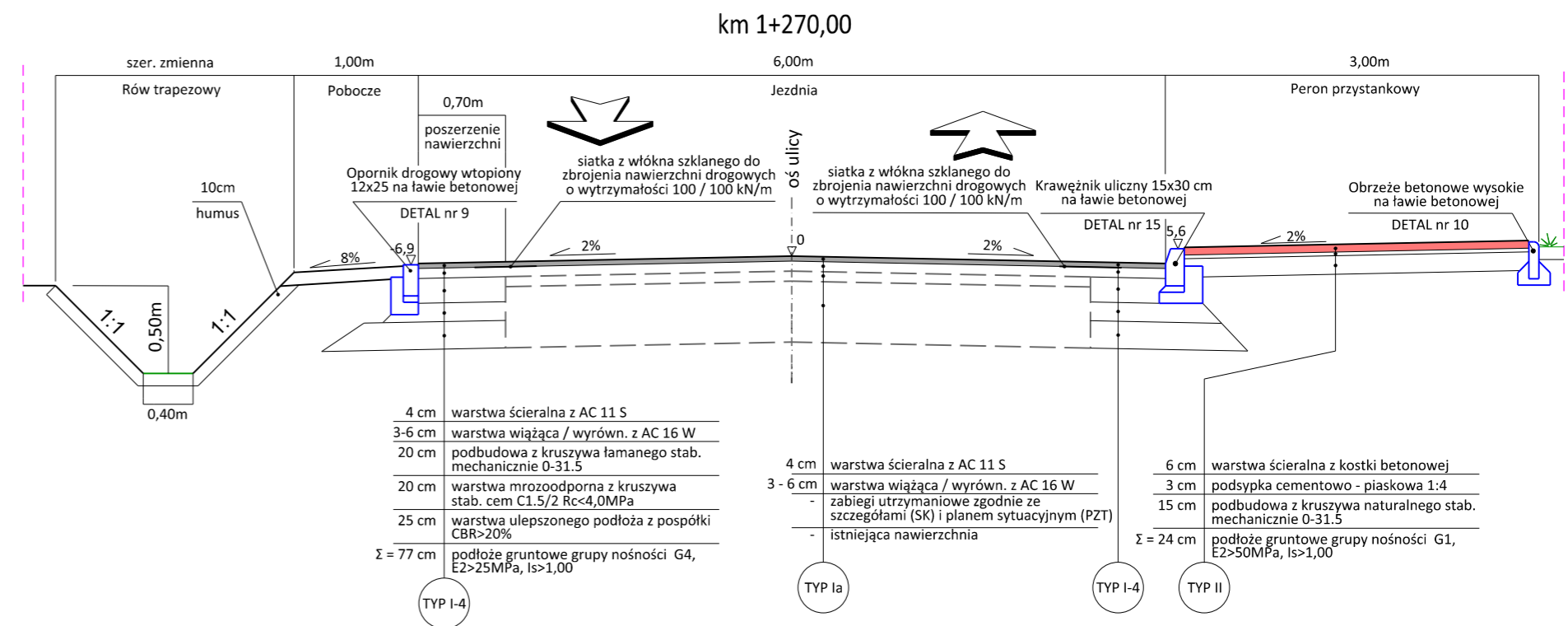
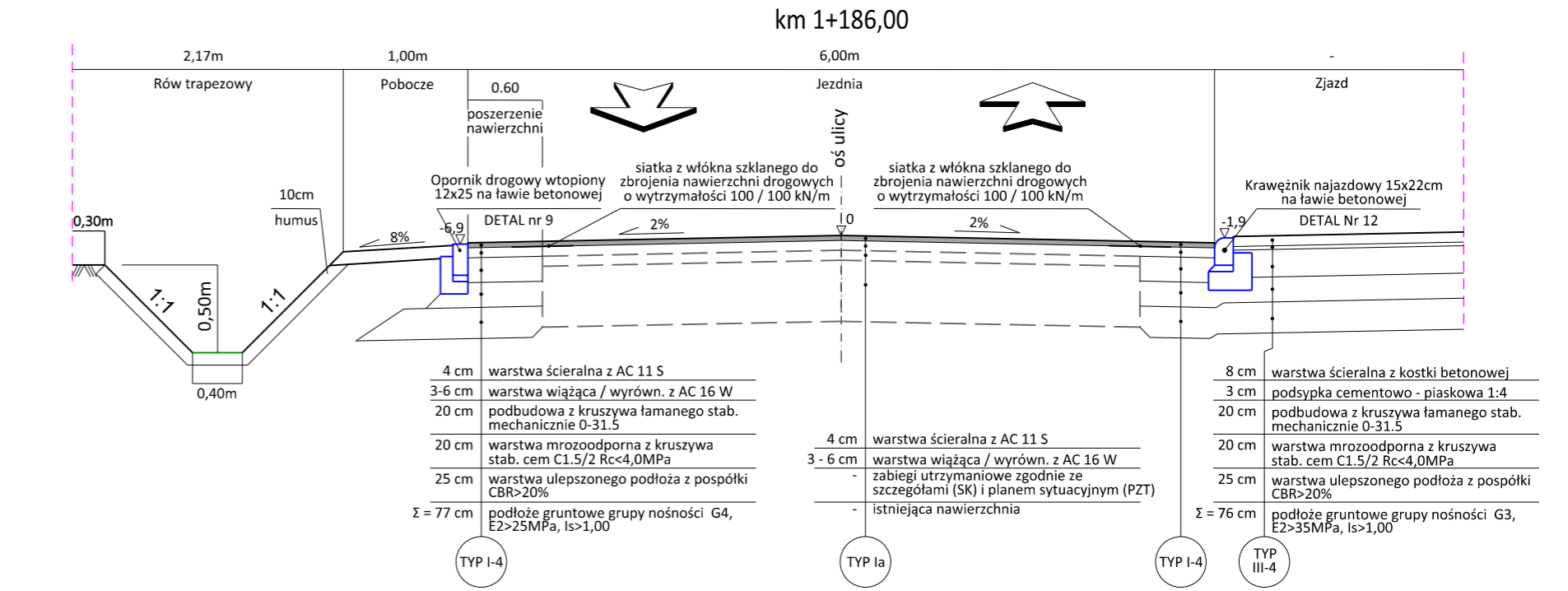
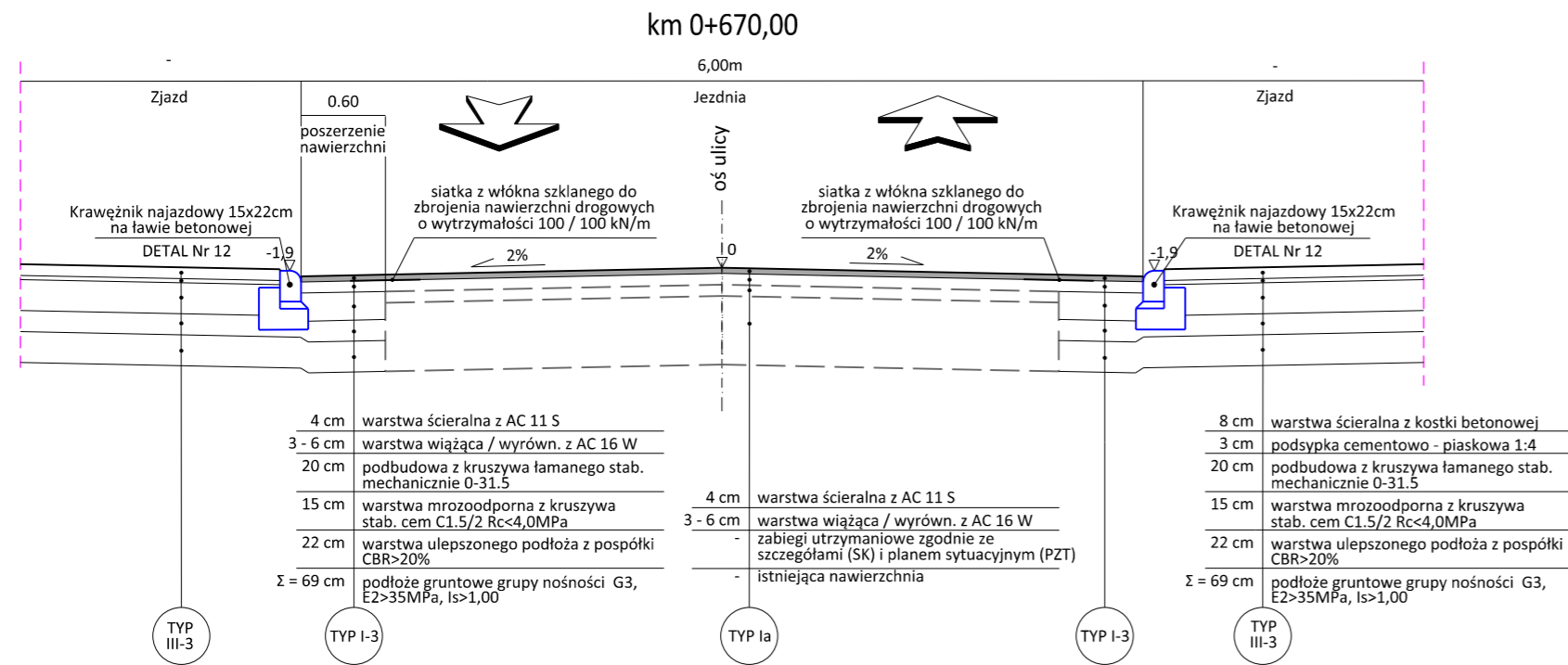



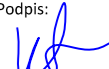

Inwestor:  Starostwo Powiatowe w Grójcu ul. Piłsudskiego 59 05-600 Grójec		Faza projektu: PROJEKT BUDOWLANO - WYKONAWCZY	
Wykonawca:  Biuro Projektów Infrastrukturalnych Krzysztof Suliga, ul. Tęczowa 3/6, 05-270 Marki tel. 791 95 65 51, email: biuro@bpi-ks.pl		Inżynieria ruchu: Projektant: mgr inż. Krzysztof Suliga upr. nr 83/DOS/12	Podpis: 
		Sprawdzający: mgr inż. Bartłomiej Małetka upr. nr MAZ/0405/POOD/10	Podpis: 
Inwestycja: PRZEBUDOWA DRÓG POWIATOWYCH NR 1602W WILCZORUDA - MICHRÓW I 1601W PNIEWY - REMBERTÓW		Tom: TOM I	Data: VIII.2017
		Skala rysunku: 1:50	Nr rysunku: PK-1601-02
		Tytuł rysunku: Przekroje konstrukcyjne	

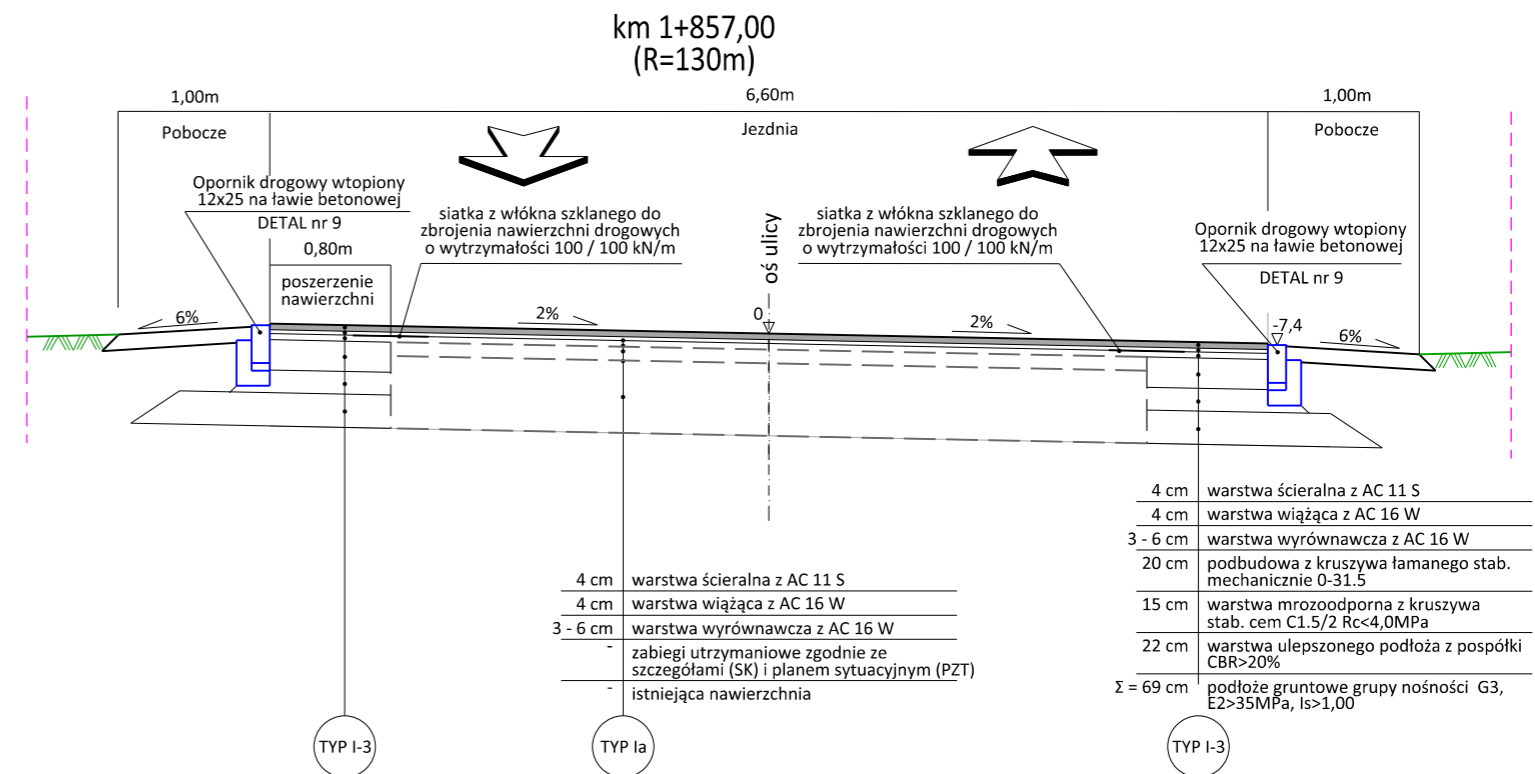
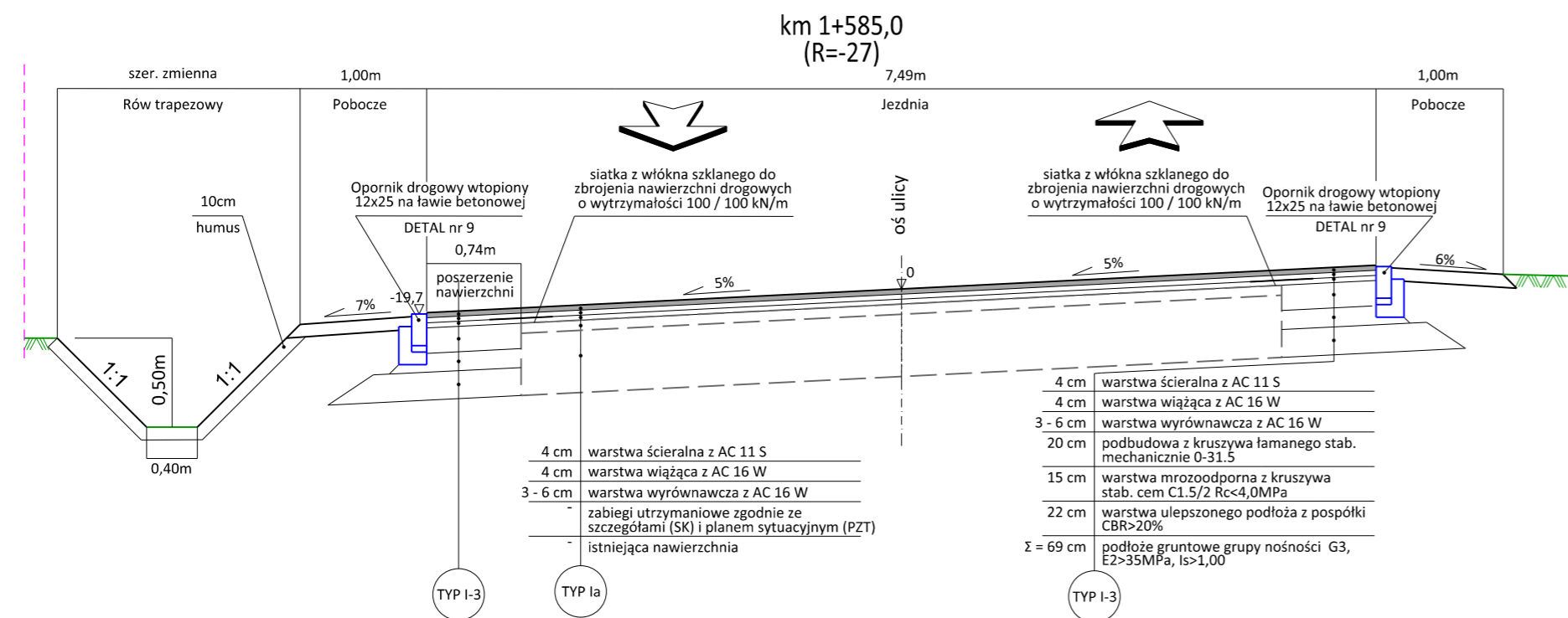

Inwestor:  Starostwo Powiatowe w Grójcu ul. Piłsudskiego 59 05-600 Grójec		Faza projektu: PROJEKT BUDOWLANO - WYKONAWCZY		
Wykonawca:  Biuro Projektów Infrastrukturalnych Krzysztof Suliga, ul. Tęczowa 3/6, 05-270 Marki tel. 791 95 65 51, email: biuro@bpi-ks.pl		Inżynieria ruchu: Projektant: mgr inż. Krzysztof Suliga upr. nr 83/DOS/12 Podpis: 	Sprawdzający: mgr inż. Bartłomiej Małetka upr. nr MAZ/0405/POOD/10 Podpis: 	
Inwestycja: PRZEBUDOWA DRÓG POWIATOWYCH NR 1602W WILCZORUDA - MICHRÓW I 1601W PNIEWY - REMBERTÓW		Tom: TOM I	Skala rysunku: 1:50	Data: VIII.2017
		Tytuł rysunku: Przekroje konstrukcyjne		Nr rysunku: PK-1601-03

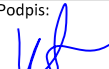

Inwestor:  Starostwo Powiatowe w Grójcu ul. Piłsudskiego 59 05-600 Grójec	Faza projektu: PROJEKT BUDOWLANO - WYKONAWCZY			
	Wykonawca:  Biuro Projektów Infrastrukturalnych Krzysztof Suliga, ul. Tęczowa 3/6, 05-270 Marki tel. 791 95 65 51, email: biuro@bpi-ks.pl		Inżynieria ruchu: Projektant: mgr inż. Krzysztof Suliga upr. nr 83/DOS/12	Podpis: 
		Sprawdzający: mgr inż. Bartłomiej Małetka upr. nr MAZ/0405/POOD/10	Podpis: 	
Inwestycja: PRZEBUDOWA DRÓG POWIATOWYCH NR 1602W WILCZORUDA - MICHRÓW I 1601W PNIEWY - REMBERTÓW		Tom: TOM I	Skala rysunku: 1:50	Data: VIII.2017
Tytuł rysunku: Przekroje konstrukcyjne			Nr rysunku: PK-1601-04	